

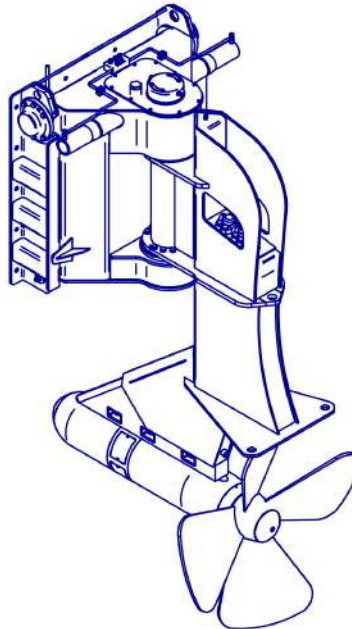

TILTABLE RUDDER PROPELLER TYPE 4200



CHARACTERISTICS	HD	LD	OPTIONS
Maximum absorbed power / RPM	448kW / 1800 rpm	584kW / 1800 rpm	Hydraulic tilting Steering indicator Tilting indicator Nozzle
Maximum HP pressure	300 bar	300 bar	
Steering angle	+/- 90°	+/- 90°	
Tilting angle	50°	50°	
Weight	2700 kg	2700 kg	
Maximum pressure on drain port	2 bar	2 bar	
Maximum auxiliary pressure	180 bar	180 bar	
Propulsive propeller diameter	around 1350mm	around 1200mm	
Number of blades	4	4	
HP Port	2 x SAE 2" 6000	2 x SAE 2" 6000	
Drain port	1 x MJIC 1"5/16	1 x MJIC 1"5/16	
Auxiliary port	5 x MJIC 9/16	5 x MJIC 9/16	

Type Approval certification by Bureau Veritas

IMPORTANT : Pipes cleanliness should be Class 7 to 8 according to NAS 1638

Document N° EB130N3-20

This document is HYDRO ARMOR property. It can't be reproduced or transmitted. It is given at information title and can be modify

HYDRO-ARMOR - Z.A. du Rohou - 29252 PLOUEZOCH - FRANCE
Tél: +33.(0)2.98.67.28.61-Fax: +33.(0)2.98.67.29.23 E-Mail : contact@hydro-armor.fr

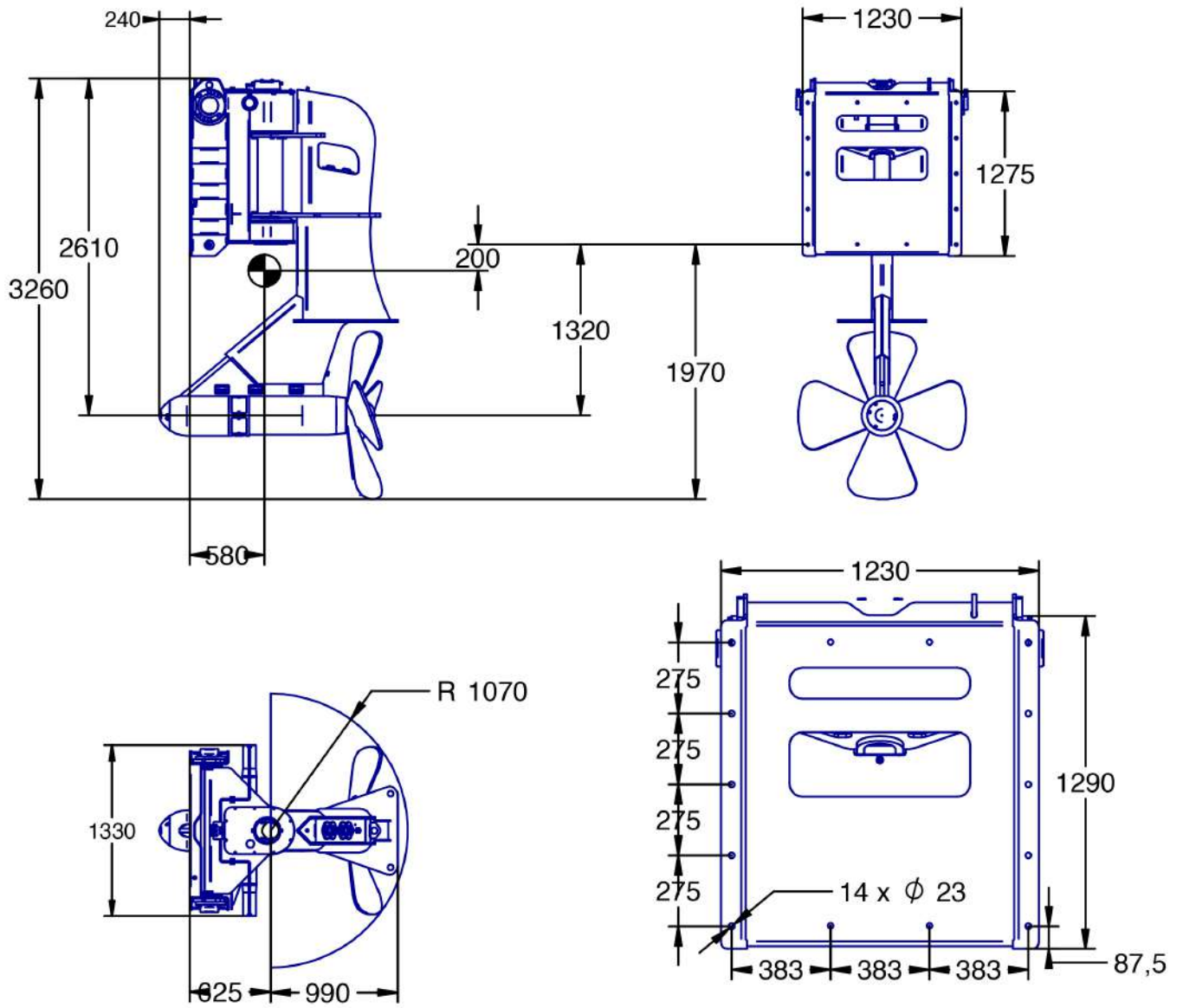

IMPLANTATION

