

PLEASURECRAFT

**IN-BOARD/
OUTBOARD/
STERNDRIVE
ANODES**

BRP™ OMC/JOHNSON EVINRUDE *anodes*

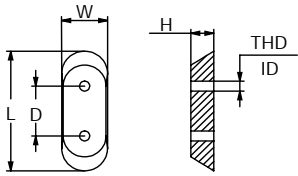

| | PID | LB | KG | | L | W | H | D | THD | ID | UPC |
|----|-----------|------|------|----|-----|-----|------|----|-----|----|-----------------|
| AL | CM123009A | 0.07 | 0.03 | mm | 61 | 23 | 12 | 26 | 10- | -- | 6 28309 12670 4 |
| MG | CM123009M | 0.05 | 0.02 | | | | | 24 | | | 6 28309 11320 9 |
| ZN | CM123009Z | 0.19 | 0.09 | in | 2.4 | 0.9 | 0.45 | 1 | UNC | | 6 28309 11321 6 |

ENGINES 70-90 HP

| | PID | LB | KG | | L | W | H | D | THD | ID | UPC |
|----|-----------|------|------|----|-----|-----|------|----|-----|-----|-----------------|
| AL | CM327606A | 0.07 | 0.03 | mm | 61 | 23 | 12 | 26 | | 0.2 | 6 28309 12338 3 |
| MG | CM327606M | 0.04 | 0.02 | | | | | | | | 6 28309 12682 7 |
| ZN | CM327606Z | 0.18 | 0.08 | in | 2.4 | 0.9 | 0.45 | 1 | | 5.1 | 6 28309 10014 8 |

JOHNSON 2-150 HP

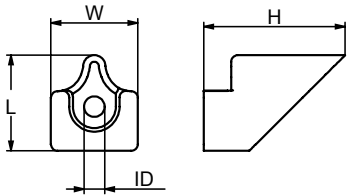

| | PID | LB | KG | | L | W | H | ID | UPC |
|----|-----------|------|-------|----|-----|------|------|------|-----------------|
| AL | CM334451A | 0.09 | 0.04 | mm | 33 | 29.8 | 48.5 | 6.9 | 6 28309 12338 3 |
| MG | CM334451M | 0.05 | 0.023 | | | | | | 6 28309 17603 7 |
| ZN | CM334451Z | 0.24 | 0.11 | in | 1.3 | 1.17 | 1.91 | 0.27 | 6 28309 19249 5 |

JOHNSON 4 - 7,5 HP EVINRUDE 4 - 7,5 HP

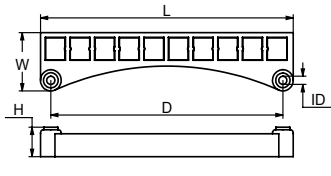

| | PID | LB | KG | | L | W | H | D | ID | UPC |
|----|--------|------|------|----|-----|-----|------|------|------|-----------------|
| AL | CM367A | 0.37 | 0.1 | mm | 193 | 43 | 22 | 179 | 6.4 | 6 28309 12672 8 |
| MG | CM367M | 0.24 | 0.11 | | | | | | | 6 28309 12683 4 |
| ZN | CM367Z | 0.95 | 0.43 | in | 7.6 | 1.7 | 0.87 | 7.05 | 0.25 | 6 28309 10021 6 |

OMC P

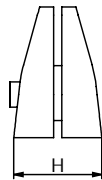
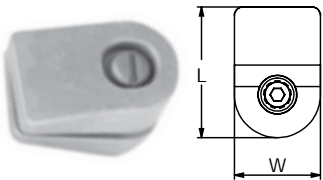

| | PID | LB | KG | | L | W | H | UPC |
|----|-----------|------|------|----|-----|------|------|-----------------|
| AL | CM389999A | 0.19 | 0.09 | mm | 48 | 31 | 32.5 | 6 28309 24165 0 |
| MG | CM389999M | 0.13 | 0.06 | | | | | 6 28309 24271 8 |
| ZN | CM389999Z | 0.5 | 0.23 | in | 1.9 | 1.23 | 1.28 | 6 28309 11322 3 |

SAILDRIVE

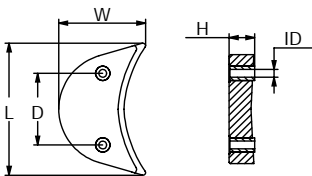

| | PID | LB | KG | | L | W | H | D | ID | UPC |
|----|-----------|------|------|----|-----|----|------|------|------|-----------------|
| AL | CM392123A | 0.65 | 0.29 | mm | 120 | 76 | 22 | 63.5 | 6.9 | 6 28309 19256 3 |
| MG | CM392123M | 0.42 | 0.19 | | | | | | | 6 28309 19288 4 |
| ZN | CM392123Z | 1.67 | 0.76 | in | 4.7 | 3 | 0.88 | 2.5 | 0.27 | 6 28309 10032 2 |

OMC 90 - 140 HP JOHNSON 90 - 140 HP EVINRUDE 90 - 140 HP

BRP™ OMC/JOHNSON EVINRUDE anodes

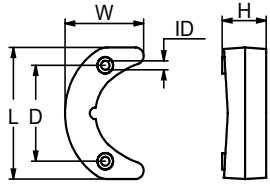

| | PID | LB | KG | | L | W | H | D | ID | UPC |
|----|-----------|------|------|----|-----|-----|-----|-----|------|-----------------|
| AL | CM392462A | 0.56 | 0.25 | mm | 102 | 64 | 36 | 74 | 6.9 | 6 28309 12673 5 |
| MG | CM392462M | 0.36 | 0.16 | | | | | | | 6 28309 12684 1 |
| ZN | CM392462Z | 1.44 | 0.65 | in | 4 | 2.5 | 1.4 | 2.9 | 0.27 | 6 28309 10034 6 |

OMC 50 - 75 HP JOHNSON 50 - 75 HP EVINRUDE 50 - 75 HP

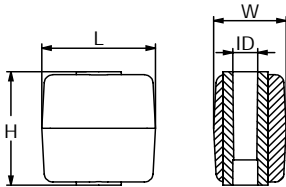

| | PID | LB | KG | | L | W | H | ID | UPC |
|----|-----------|------|------|----|-----|----|------|------|-----------------|
| AL | CM393023A | 0.19 | 0.09 | mm | 40 | 25 | 41 | 8.1 | 6 28309 12674 2 |
| MG | CM393023M | 0.12 | 0.05 | | | | | | 6 28309 12685 8 |
| ZN | CM393023Z | 0.48 | 0.22 | in | 1.6 | 1 | 1.63 | 0.32 | 6 28309 10035 3 |

(Supercedes to CM436705)

OMC 50 - 60 - 70 - 90 - 140 HP JOHNSON 50 - 115 - 120 - 140 HP EVINRUDE 50-140 - 200 HP

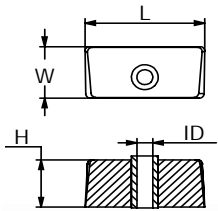

| | PID | LB | KG | | L | W | H | ID | UPC |
|----|-----------|------|------|----|-----|-----|-----|------|-----------------|
| AL | CM397768A | 0.26 | 0.12 | mm | 64 | 31 | 28 | 8.1 | 6 28309 12675 9 |
| MG | CM397768M | 0.17 | 0.08 | | | | | | 6 28309 12686 5 |
| ZN | CM397768Z | 0.68 | 0.31 | in | 2.5 | 1.2 | 1.1 | 0.32 | 6 28309 10037 7 |

OMC COBRA

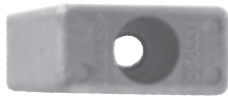
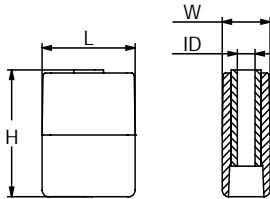

| | PID | LB | KG | | L | W | H | ID | UPC |
|----|-----------|------|------|----|------|-----|------|------|-----------------|
| AL | CM398331A | 0.28 | 0.13 | mm | 45 | 23 | 57 | 8.1 | 6 28309 12676 6 |
| MG | CM398331M | 0.18 | 0.08 | | | | | | 6 28309 12687 2 |
| ZN | CM398331Z | 0.73 | 0.33 | in | 1.75 | 0.9 | 2.25 | 0.32 | 6 28309 10039 1 |

JOHNSON 160 - 280 HP (V4 - V6) EVINRUDE

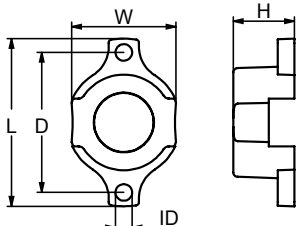

| | PID | LB | KG | | L | W | H | D | ID | UPC |
|----|-----------|------|------|----|----|-----|------|------|-----|-----------------|
| AL | CM398873A | 0.13 | 0.06 | mm | 76 | 48 | 27.9 | 64.5 | 7.6 | 6 28309 12677 3 |
| MG | CM398873M | 0.08 | 0.04 | | | | | | | 6 28309 12688 9 |
| ZN | CM398873Z | 0.33 | 0.15 | in | 3 | 1.9 | 1.1 | 2.54 | 0.3 | 6 28309 10041 4 |

JOHNSON 737

BRP™ OMC/JOHNSON EVINRUDE anodes

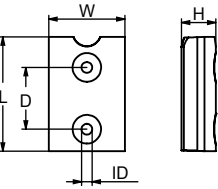

| | PID | LB | KG | | L | W | H | D | ID | UPC |
|----|-----------|------|------|----|------|------|-----|-----|------|-----------------|
| AL | CM431708Z | 0.23 | 0.10 | mm | 75.8 | 50.8 | 23 | 41 | 6.9 | 6 28309 42678 0 |
| MG | CM431708A | 0.15 | 0.07 | | | | | | | 6 28309 12689 6 |
| ZN | CM431708M | 0.6 | 0.27 | in | 3 | 2 | 0.9 | 1.6 | 0.27 | 6 28309 10049 0 |

JOHNSON - EVINRUDE - DIABOLO 70 - 120 HP

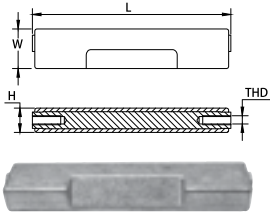

| | PID | LB | KG | | L | W | H | THD | UPC |
|----|------------|------|------|----|--------|-------|-------|----------------|-----------------|
| AL | CM5007089Z | 0.68 | 0.31 | mm | 174.24 | 34.79 | 21.33 | 5/16-18 UNC | 6 28309 19257 0 |
| MG | CM5007089A | 0.5 | 0.22 | | | | | | 6 28309 19293 8 |
| ZN | CM5007089M | 1.5 | 0.68 | in | 6.86 | 1.37 | 0.84 | | 6 28309 11307 0 |

(CM433580Z) JOHNSON - EVINRUDE 60/ 300 HP

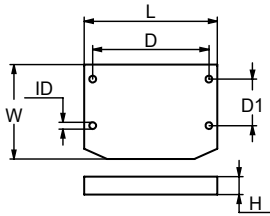

| | PID | LB | KG | | L | W | H | D | D1 | ID | UPC |
|----|-----------|------|------|----|-----|-----|-----|-----|-----|------|-----------------|
| AL | CM980756Z | 0.82 | 0.37 | mm | 117 | 80 | 16 | 102 | 41 | 7 | 6 28309 24182 7 |
| MG | CM980756A | 0.53 | 0.24 | | | | | | | | 6 28309 24292 3 |
| ZN | CM980756M | 2.11 | 0.96 | in | 4.6 | 3.2 | 0.6 | 4 | 1.6 | 0.28 | 6 28309 10145 9 |

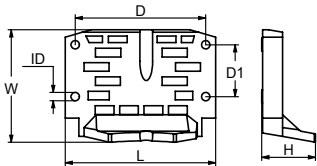

| | PID | LB | KG | | L | W | H | D | D1 | ID | UPC |
|----|-----------|------|------|----|-----|------|-----|-----|-----|------|-----------------|
| AL | CM982277Z | 0.72 | 0.33 | mm | 117 | 85 | 41 | 102 | 41 | 7 | 6 28309 24183 4 |
| MG | CM982277A | 0.47 | 0.21 | | | | | | | | 6 28309 24293 0 |
| ZN | CM982277M | 1.87 | 0.85 | in | 4.6 | 3.33 | 1.6 | 4 | 1.6 | 0.28 | 6 28309 10146 6 |

OMC M (100-245 HP)



| | PID | LB | KG | | L | W | H | D | THD | UPC |
|----|-----------|------|------|----|------|------|------|------|-------------|-----------------|
| AL | CM983494Z | 0.7 | 0.32 | mm | 146 | 104 | 25 | 113 | ¼-20 UNC | 6 28309 12679 7 |
| MG | CM983494A | 0.45 | 0.20 | | | | | | | 6 28309 12690 2 |
| ZN | CM983494M | 1.81 | 0.82 | in | 5.72 | 4.09 | 0.98 | 4.44 | | 6 28309 10149 7 |

OMC 90 HP

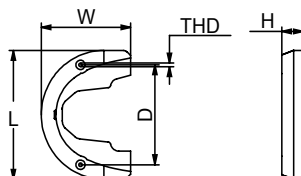

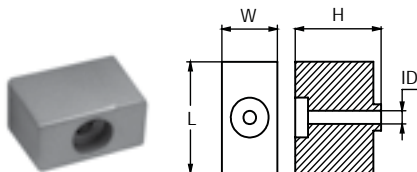
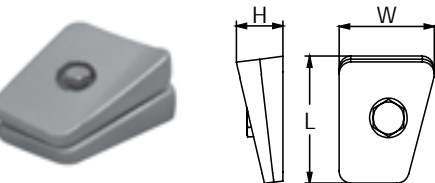
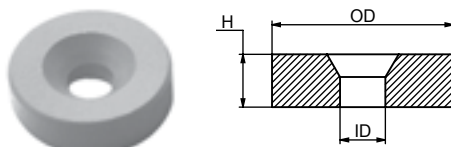
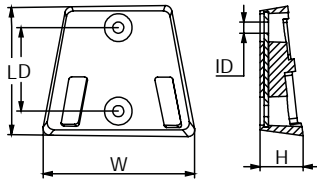
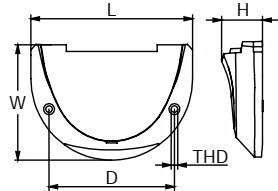
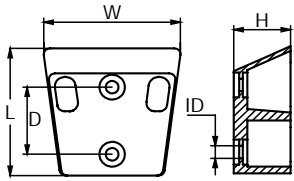

BRP™ OMC/JOHNSON EVINRUDE anodes

| | PID | LB | KG | | L | W | H | D | ID | UPC |
|----|-----------|------|------|----|-----|-----|------|------|------|-----------------|
| AL | CM983952A | 0.95 | 0.43 | mm | 107 | 112 | 46.5 | 57.2 | 10.5 | 6 28309 24185 8 |
| MG | CM983952M | 0.67 | 0.3 | | | | | | | 6 28309 24295 4 |
| ZN | CM983952Z | 2.44 | 1.1 | in | 4.2 | 4.4 | 1.8 | 2.25 | 0.4 | 6 28309 10150 3 |

OMC COBRA 130- 385 HP

| | PID | LB | KG | | L | W | H | D | THD | UPC |
|----|-----------|------|------|----|-----|-----|------|------|---------------|-----------------|
| AL | CM984513A | 0.83 | 0.38 | mm | 145 | 104 | 40.6 | 113 | 1/4-20 UNC | 6 28309 12680 3 |
| MG | CM984513M | 0.59 | 0.27 | | | | | | | 6 28309 10152 7 |
| ZN | CM984513Z | 2.14 | 0.97 | in | 5.7 | 4.1 | 1.6 | 4.44 | | 6 28309 10153 4 |

| | PID | LB | KG | | L | W | H | D | ID | UPC |
|----|-----------|------|------|----|-----|-----|------|------|------|-----------------|
| AL | CM984547A | 0.78 | 0.35 | mm | 97 | 115 | 32 | 57 | 10 | 6 28309 12681 0 |
| MG | CM984547M | 0.50 | 0.23 | | | | | | | 6 28309 12691 9 |
| ZN | CM984547Z | 2 | 0.91 | in | 3.8 | 4.5 | 1.24 | 2.25 | 0.38 | 6 28309 10155 8 |

OMC COBRA BASSA

| | PID | LB | KG | | OD | H | ID | UPC |
|----|------------|------|------|----|-----|-----|------|-----------------|
| ZN | CM5031705Z | 0.04 | 0.02 | mm | 24 | 7 | 7 | 6 28309 24104 9 |
| | | | | in | 0.9 | 0.3 | 0.26 | |

HONDA 8/20HP

| | PID | LB | KG | | L | W | H | UPC |
|----|-----------|------|------|----|----|-----|------|-----------------|
| ZN | CM434029Z | 0.42 | 0.19 | mm | 50 | 42 | 24 | 6 28309 23197 2 |
| | | | | in | 2 | 1.7 | 0.94 | |

DOUBLE PLATE
JOHNSON 521 20 - 25 HP 1991 EVINRUDE 20 - 25 HP 1991

| | PID | LB | KG | | L | W | H | ID | UPC |
|----|-----------|-------|-------|----|----|-----|-----|------|-----------------|
| AL | CM395780A | 0.169 | 0.077 | mm | 42 | 22 | 31 | 8 | 6 28309 23338 9 |
| MG | CM395780M | 0.108 | 0.049 | | | | | | |
| ZN | CM395780Z | 0.44 | 0.2 | in | 2 | 1.6 | 1.3 | 0.31 | 6 28309 23340 2 |

PLATE 60-280HP

BRP™ OMC/JOHNSON EVINRUDE anodes

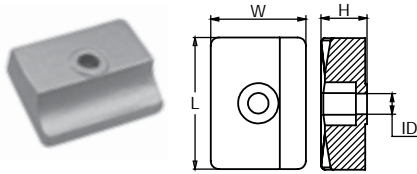

| | PID | LB | KG | | L | W | H | ID | UPC |
|----|-----------|-------|-------|----|-----|----|-----|------|-----------------|
| AL | CM338635A | 0.035 | 0.016 | mm | 36 | 26 | 13 | 6 | 6 28309 21146 2 |
| MG | CM338635M | 0.022 | 0.010 | | | | | | 6 28309 21168 4 |
| ZN | CM338635Z | 0.12 | 0.06 | in | 1.4 | 1 | 0.5 | 0.22 | 6 28309 21124 0 |

**DOUBLE PLATE OUTBOARD 9,9-15CV
JOHNSON 8 - 9,9 - 15 HP**

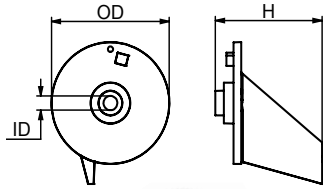

| | PID | LB | KG | | OD | H | ID | UPC |
|----|------------|-------|-------|----|-----|-----|------|-----------------|
| AL | CM5032929A | 0.192 | 0.087 | mm | 73 | 66 | 9 | 6 28309 21152 3 |
| MG | CM5032929M | 0.123 | 0.056 | | | | | 6 28309 21173 8 |
| ZN | CM5032929Z | 0.54 | 0.25 | in | 2.9 | 2.6 | 0.33 | 6 28309 21128 8 |

EVINRUDE 70 HP 4T

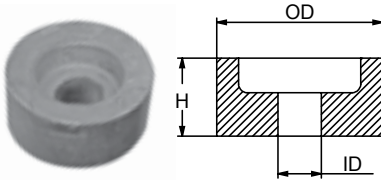

| | PID | LB | KG | | OD | H | ID | UPC |
|----|---------------|------|------|----|------|------|------|-----------------|
| AL | CM5532187J00A | 0.01 | 0.01 | mm | 21 | 10 | 6 | 6 28309 12963 7 |
| MG | CM5532187J00M | 0.01 | 0.01 | | | | | 6 28309 12428 7 |
| ZN | CM5532187J00Z | 0.03 | 0.01 | in | 0.83 | 0.39 | 0.24 | 6 28309 19252 5 |

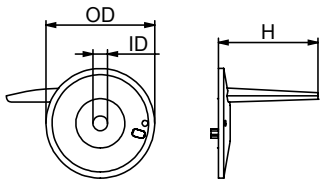

| | PID | LB | KG | | OD | H | ID | UPC |
|----|---------------|------|------|----|-----|------|------|-----------------|
| AL | CM5512595500A | 0.15 | 0.07 | mm | 62 | 57 | 9 | 6 28309 21153 0 |
| MG | CM5512595500M | 0.09 | 0.04 | | | | | 6 28309 21174 5 |
| ZN | CM5512595500Z | 0.35 | 0.16 | in | 2.4 | 2.24 | 0.33 | 6 28309 21129 5 |

SUZUKI 75 - 85 - 90 HP

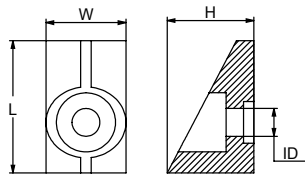

| | PID | LB | KG | | L | W | H | ID | UPC |
|----|---------------|------|------|----|-----|------|-----|------|-----------------|
| AL | CM5532098600A | 0.06 | 0.03 | mm | 38 | 40 | 23 | 6 | 6 28309 23365 5 |
| MG | CM5532098600M | 0.04 | 0.02 | | | | | | 6 28309 23366 2 |
| ZN | CM5532098600Z | 0.22 | 0.1 | in | 0.8 | 1.57 | 0.9 | 0.25 | 6 28309 23367 9 |

**SUZUKI F.B.
5 HP**

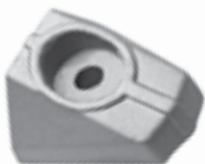

BRP™ OMC/JOHNSON EVINRUDE anodes

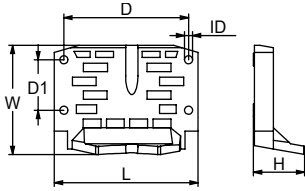

| | PID | LB | KG | | L | W | H | D | D1 | ID | UPC |
|----|-----------|------|------|----|-----|-----|-----|-----|-----|------|-----------------|
| ZN | CM982438Z | 2.67 | 1.21 | mm | 176 | 81 | 40 | 102 | 41 | 7 | 6 28309 24115 5 |
| | | | | in | 6.9 | 3.2 | 1.6 | 4 | 1.6 | 0.28 | |

OMC 100-245 HP

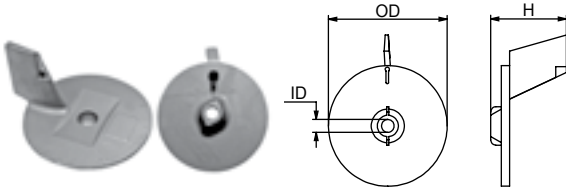

| | PID | LB | KG | | OD | H | ID | UPC |
|----|-----------|------|-----|----|-----|-----|------|-----------------|
| ZN | CM338742Z | 0.88 | 0.4 | mm | 113 | 72 | 11 | 6 28309 23337 2 |
| | | | | in | 4.4 | 2.8 | 0.43 | |

REVOLVING FIN FOR IN-OUTBOARD
OMC E.B. - F.B. - 55 HP

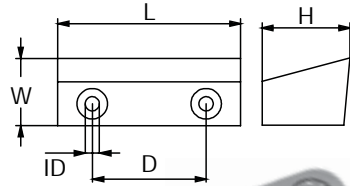

| | PID | LB | KG | | L | W | H | D | ID | UPC |
|----|-----------|------|-------|----|-----|------|-----|----|------|-----------------|
| AL | CM986158A | 0.52 | 0.236 | mm | 90 | 45 | 43 | 51 | 10 | 6 28309 24186 5 |
| MG | CM986158M | 0.33 | 0.15 | | | | | | | 6 28309 24296 1 |
| ZN | CM986158Z | 1.33 | 0.6 | in | 3.5 | 1.77 | 1.7 | 2 | 0.37 | 6 28309 24116 2 |

OMC COBRA

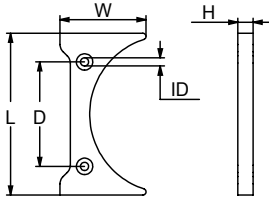

| | PID | LB | KG | | L | W | H | D | ID | UPC |
|----|-----------|------|-------|----|-----|-----|-----|-----|-----|-----------------|
| AL | CM987067A | 0.59 | 0.269 | mm | 158 | 84 | 15 | 102 | 8 | 6 28309 24187 2 |
| MG | CM987067M | 0.37 | 0.17 | | | | | | | 6 28309 24297 8 |
| ZN | CM987067Z | 1.59 | 0.72 | in | 6.2 | 3.3 | 0.6 | 4 | 0.3 | 6 28309 24117 9 |

OMC5700

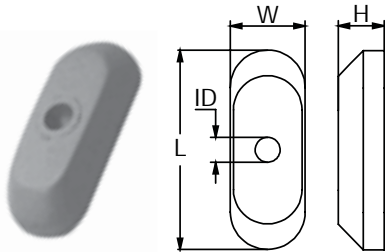

| | PID | LB | KG | | L | W | H | ID | UPC |
|----|---------------|------|------|----|-----|-----|-----|-----|-----------------|
| ZN | CM5532098400Z | 0.11 | 0.05 | mm | 48 | 18 | 11 | 6 | 6 28309 21130 1 |
| | | | | in | 1.9 | 0.7 | 0.4 | 0.2 | |

SUZUKI 2 HP

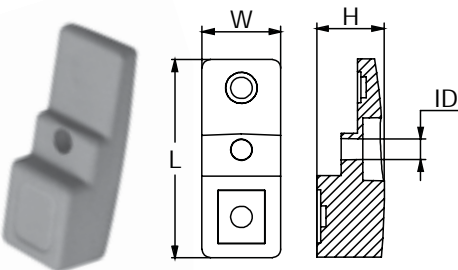

| | PID | LB | KG | | L | W | H | ID | UPC |
|----|---------------|------|------|----|-----|-----|-----|-----|-----------------|
| ZN | CM5532190J01Z | 0.19 | 0.09 | mm | 55 | 22 | 19 | 6 | 6 28309 21131 8 |
| | | | | in | 2.2 | 0.9 | 0.7 | 0.2 | |

DF 90 - 115 - 140



BRP™ OMC/JOHNSON EVINRUDE anodes

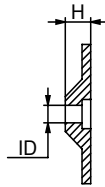
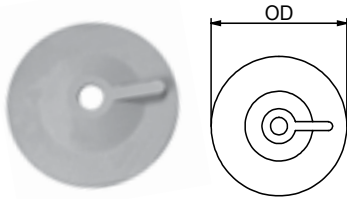

| | PID | LB | KG | | OD | H | ID | UPC |
|----|---------------|------|------|----|-----|-----|------|-----------------|
| ZN | CM5532193900Z | 0.13 | 0.06 | mm | 48 | 9 | 7 | 6 28309 20935 3 |
| | | | | in | 1.9 | 0.4 | 0.26 | |

PLATE 9.9-15 HP

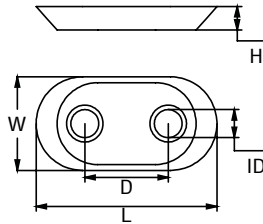

| | PID | LB | KG | | L | W | H | D | ID | UPC |
|----|------------|------|------|----|-----|------|-----|-----|------|-----------------|
| ZN | CM5031538Z | 0.17 | 0.08 | mm | 78 | 20 | 10 | 40 | 7 | 6 28309 24103 2 |
| | | | | in | 3.1 | 0.79 | 0.4 | 1.6 | 0.26 | |

PLATE 2-8 HP

BRP™ anode kits



| | PID | LB | KG | Contains | Fits | UPC |
|----|--------------|------|------|--|------------------------|-----------------|
| AL | CMSTRGERKITA | 1.4 | 0.63 | CM983494 X 1 CM393023 X 1 CM431708 X 1 | BRP OMC Stringer | 6 28309 24965 6 |
| MG | CMSTRGERKITM | 1.07 | 0.48 | | | 6 28309 24966 3 |
| ZN | CMSTRGERKITZ | 2.95 | 1.34 | | | 6 28309 24982 3 |

BRP OMC Stringer



| | PID | LB | KG | Contains | Fits | UPC |
|----|-------------|------|------|--|------------------|-----------------|
| AL | CMCOBRAKITA | 1.65 | 0.75 | CM984513 X 1 CM393023 X 1 CM431708 X 1 | BRP OMC COBRA | 6 28309 24950 2 |
| MG | CMCOBRAKITM | 1.25 | 0.57 | | | 6 28309 24951 9 |
| ZN | CMCOBRAKITZ | 3.69 | 1.68 | | | 6 28309 24952 6 |

BRP OMC COBRA

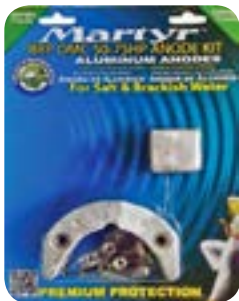

| | PID | LB | KG | Contains | Fits | UPC |
|----|---------------|------|------|------------------------------|-----------------------|-----------------|
| AL | CMOMC5075KITA | 1.11 | 0.50 | CM393023 X 1 CM392462 X 1 | BRP OMC 50-75HP | 6 28309 24956 4 |
| MG | CMOMC5075KITM | 0.89 | 0.41 | | | 6 28309 24957 1 |
| ZN | CMOMC5075KITZ | 2.25 | 1.02 | | | 6 28309 24958 8 |

BRP OMC 50-75HP



| | PID | LB | KG | Contains | Fits | UPC |
|----|---------------|------|------|------------------------------|---------------------|-----------------|
| AL | CMOMCV4V6KITA | 1.17 | 0.53 | CM393023 X 1 CM392123 X 1 | BRP OMC V4-V6 | 6 28309 24959 5 |
| MG | CMOMCV4V6KITM | 0.93 | 0.42 | | | 6 28309 24960 1 |
| ZN | CMOMCV4V6KITZ | 2.45 | 1.11 | | | 6 28309 24961 8 |

BRP OMC V4-V6

ALL KITS INCLUDE FASTENING HARDWARE, INSTALLATION INSTRUCTIONS, AND ALL OF THE ANODES REQUIRED FOR 100% PROTECTION.

BMW™ anodes

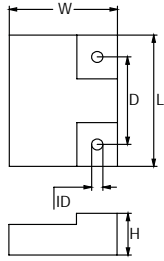

| | PID | LB | KG | | L | W | H | D | ID | UPC |
|----|----------|------|------|----|-----|-----|----|-----|------|-----------------|
| ZN | CMBW175Z | 0.71 | 0.32 | mm | 60 | 48 | 26 | 40 | 8 | 6 28309 24118 6 |
| | | | | in | 2.4 | 1.9 | 1 | 1.6 | 0.33 | |

BMW100 MARK1

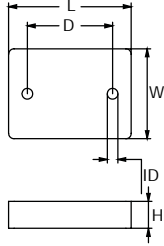

| | PID | LB | KG | | L | W | H | D | ID | UPC |
|----|----------|------|------|----|-----|----|-----|-----|-----|-----------------|
| ZN | CMBW499Z | 0.74 | 0.34 | mm | 69 | 50 | 15 | 48 | 6 | 6 28309 23576 5 |
| | | | | in | 2.7 | 2 | 0.6 | 1.9 | 0.2 | |

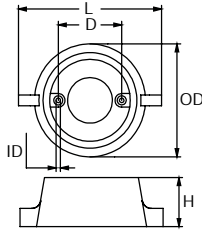

| | PID | LB | KG | | L | H | D | OD | ID | UPC |
|----|----------|------|------|----|-----|-----|------|-----|------|-----------------|
| ZN | CMBW172Z | 1.83 | 0.83 | mm | 165 | 54 | 80 | 124 | 8 | 6 28309 24651 8 |
| | | | | in | 6.5 | 2.1 | 3.15 | 4.9 | 0.33 | |

BMW MARK1

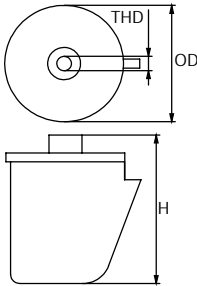

| | PID | LB | KG | | OD | H | THD | UPC |
|----|----------|------|------|----|-----|-----|------------|-----------------|
| ZN | CMBW173Z | 0.73 | 0.33 | mm | 65 | 83 | 3/8-16 UNC | 6 28309 24652 5 |
| | | | | in | 2.6 | 3.3 | | |

BMW MARK1

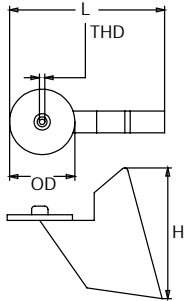

| | PID | LB | KG | | L | W | OD | THD | UPC |
|----|----------|-----|------|----|-----|-----|------|------------|-----------------|
| ZN | CMBW043Z | 1.5 | 0.68 | mm | 165 | 120 | 65 | 3/8-16 UNC | 6 28309 23573 4 |
| | | | | in | 6.5 | 4.7 | 2.56 | | |

BMW MARK2

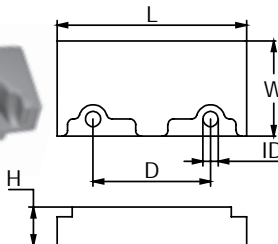

| | PID | LB | KG | | L | W | H | D | ID | UPC |
|----|----------|------|------|----|------|------|------|------|------|-----------------|
| ZN | CMBW044Z | 2.07 | 0.94 | mm | 119 | 59 | 30 | 62 | 9 | 6 28309 24650 1 |
| | | | | in | 4.69 | 2.32 | 1.18 | 2.44 | 0.33 | |

BMW MARK2

BUKH™ anodes

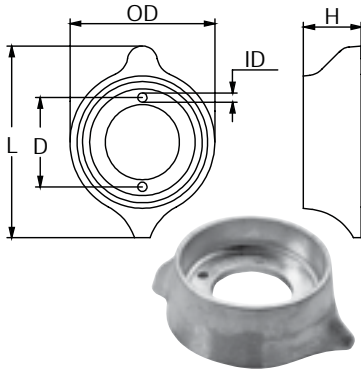

| | PID | LB | KG | | OD | L | H | D | ID | UPC |
|----|-------------|------|------|----|-----|-----|-----|------|------|-----------------|
| AL | CMB00E5829A | 0.71 | 0.32 | mm | 107 | 140 | 43 | 68 | 7 | 6 28309 19260 0 |
| MG | CMB00E5829M | 0.5 | 0.23 | | | | | | | 6 28309 19304 1 |
| ZN | CMB00E5829Z | 1.82 | 0.83 | in | 4.2 | 5.5 | 1.7 | 2.66 | 0.27 | 6 28309 12201 0 |

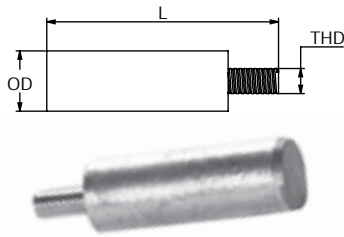

| | PID | LB | KG | | OD | L | THD | UPC |
|----|-------------|------|------|----|-----|-----|-----|-----------------|
| AL | CMB00E0450A | 0.02 | 0.01 | mm | 12 | 46 | M5 | 6 28309 23559 8 |
| MG | CMB00E0450M | 0.02 | 0.01 | | | | | 6 28309 23560 4 |
| ZN | CMB00E0450Z | 0.06 | 0.03 | in | 0.5 | 1.8 | | 6 28309 12182 2 |

CASTOLDI™ anodes

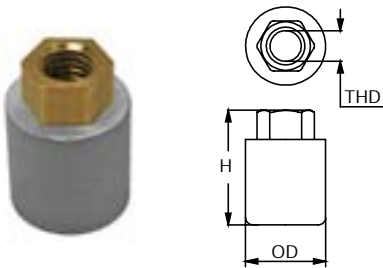

| | PID | LB | KG | | OD | H | THD | UPC |
|----|--------------|------|-------|----|-----|-----|-----|-----------------|
| AL | CM590140552A | 0.08 | 0.039 | mm | 22 | 30 | M10 | 6 28309 21156 1 |
| MG | CM590140552M | 0.07 | 0.033 | | | | | 6 28309 21156 1 |
| ZN | CM590140552Z | 0.14 | 0.06 | in | 0.9 | 1.2 | | 6 28309 21132 5 |

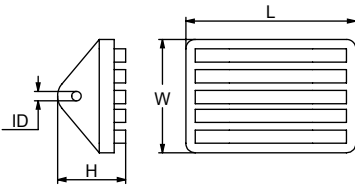

| | PID | LB | KG | | L | W | H | ID | UPC |
|----|--------------|------|------|----|-----|-----|-----|------|-----------------|
| ZN | CM542150626Z | 1.8 | 0.82 | mm | 90 | 60 | 53 | 13 | 6 28309 23355 6 |
| | | | | in | 3.5 | 2.4 | 2.1 | 0.49 | |
| ZN | CM542160824Z | 0.94 | 0.43 | mm | 120 | 70 | 74 | 14 | 6 28309 23358 7 |
| | | | | in | 4.7 | 2.7 | 2.9 | 0.56 | |

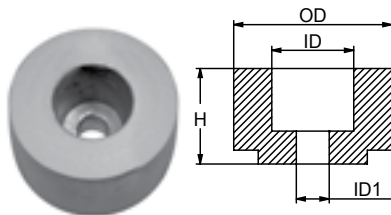
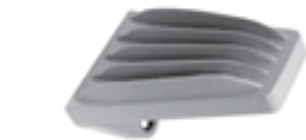

| | PID | LB | KG | | OD | H | ID | ID1 | UPC |
|----|--------------|------|-------|----|------|------|------|------|-----------------|
| AL | CM590163243A | 0.43 | 0.196 | mm | 58 | 35 | 25 | 9 | 6 28309 23386 0 |
| MG | CM590163243M | 0.27 | 0.124 | | | | | | 6 28309 23387 7 |
| ZN | CM590163243Z | 1.12 | 0.51 | in | 2.28 | 1.38 | 0.98 | 0.36 | 6 28309 23388 4 |
| AL | CM59066209A | 1.22 | 0.555 | mm | 80 | 50 | 30 | 10 | 6 28309 23389 1 |
| MG | CM59066209M | 0.77 | 0.352 | | | | | | 6 28309 23390 7 |
| ZN | CM59066209Z | 3.3 | 1.5 | in | 3.15 | 1.97 | 1.18 | 0.4 | 6 28309 23391 4 |

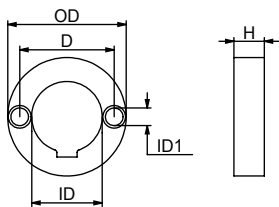

DUFOUR™ anodes

| | PID | LB | KG | | OD | H | D | ID | ID1 | UPC |
|----|---------|------|------|----|-----|-----|------|------|------|-----------------|
| ZN | CMDU22Z | 0.2 | 0.09 | mm | 47 | 12 | 35 | 27 | 7 | 6 28309 24121 6 |
| | | | | in | 1.8 | 0.5 | 1.39 | 1.06 | 0.26 | |
| ZN | CMDU25Z | 0.31 | 0.14 | mm | 52 | 15 | 39 | 28 | 7 | 6 28309 24122 3 |
| | | | | in | 2 | 0.6 | 1.52 | 1.1 | 0.26 | |
| ZN | CMDU30Z | 0.4 | 0.18 | mm | 55 | 18 | 43 | 33 | 7 | 6 28309 24123 0 |
| | | | | in | 2.2 | 0.7 | 1.69 | 1.3 | 0.26 | |

HIDEA™ anodes

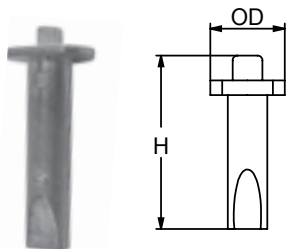

| | PID | LB | KG | | OD | H | UPC |
|----|---------------|------|------|----|------|------|-----------------|
| ZN | CM6J81132500Z | 0.03 | 0.02 | mm | 16 | 41 | 6 28309 19539 7 |
| | | | | in | 0.63 | 1.61 | |

Also apply to Painier

HONDA™ anodes

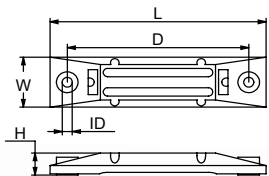

| | PID | LB | KG | | L | W | H | D | ID | UPC |
|----|-------------|------|------|----|-----|-----|-----|-----|-----|-----------------|
| AL | CM06411ZV5A | 0.31 | 0.14 | mm | 150 | 36 | 16 | 126 | 7 | 6 28309 17552 8 |
| MG | CM06411ZV5M | 0.2 | 0.09 | | | | | | | 6 28309 17043 1 |
| ZN | CM06411ZV5Z | 0.79 | 0.36 | in | 5.9 | 1.4 | 0.6 | 4.9 | 0.3 | 6 28309 11373 5 |

40/50 HP

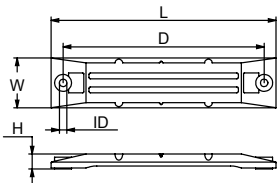

| | PID | LB | KG | | L | W | H | D | ID | UPC |
|----|-------------|------|------|----|-----|----|-----|-----|-----|-----------------|
| AL | CM06411ZW1A | 0.70 | 0.32 | mm | 226 | 50 | 16 | 202 | 7 | 6 28309 17554 2 |
| MG | CM06411ZW1M | 0.44 | 0.20 | | | | | | | 6 28309 17041 7 |
| ZN | CM06411ZW1Z | 1.81 | 0.82 | in | 8.8 | 2 | 0.6 | 7.9 | 0.3 | 6 28309 11374 2 |

75 / 130 / 225 HP

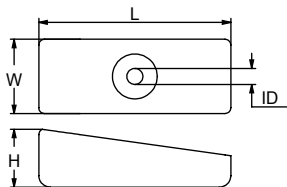

| | PID | LB | KG | | L | W | H | ID | UPC |
|----|----------------------------|------|------|----|----|------|-----|------|-----------------|
| AL | CM41109ZW1003A (CM826134A) | 0.22 | 0.1 | mm | 76 | 30 | 23 | 6 | 6 28309 24168 1 |
| MG | CM41109ZW1003M (CM826134M) | 0.15 | 0.07 | | | | | | 6 28309 24274 9 |
| ZN | CM41109ZW1003Z (CM826134Z) | 0.56 | 0.25 | in | 3 | 1.16 | 0.9 | 0.25 | 6 28309 24102 5 |

75 HP - V6 40/50 /115 EFI 4T

HONDA™ anodes

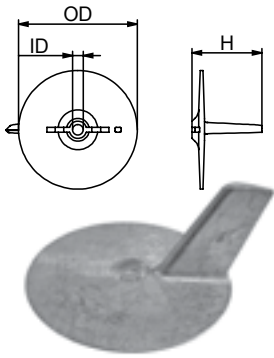

| | PID | LB | KG | | OD | H | ID | UPC |
|----|---------------|------|------|----|-----|-----|------|-----------------|
| AL | CM6644537101A | 0.23 | 0.1 | mm | 96 | 57 | 9 | 6 28309 12643 8 |
| MG | CM6644537101M | 0.16 | 0.08 | | | | | 6 28309 10064 3 |
| ZN | CM6644537101Z | 0.59 | 0.27 | in | 3.8 | 2.2 | 0.33 | 6 28309 10065 0 |

MARINER 10 - 50 HP YAMAHA 20 - 25 - 30 - 40- 50 HP

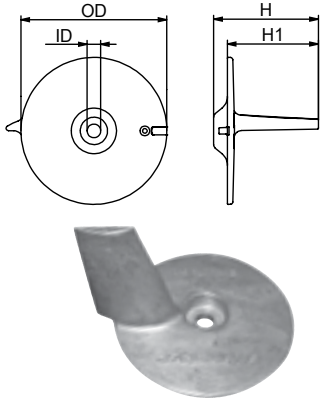

| | PID | LB | KG | | OD | H | H1 | ID | UPC |
|----|---------------|------|------|----|------|------|------|------|-----------------|
| AL | CM41107ZV500A | 0.25 | 0.11 | mm | 95 | 68 | 59 | 8 | 6 28309 12723 7 |
| MG | CM41107ZV500M | 0.17 | 0.09 | | | | | | 6 28309 19291 4 |
| ZN | CM41107ZV500Z | 0.63 | 0.29 | in | 3.74 | 2.68 | 2.33 | 0.33 | 6 28309 17045 5 |

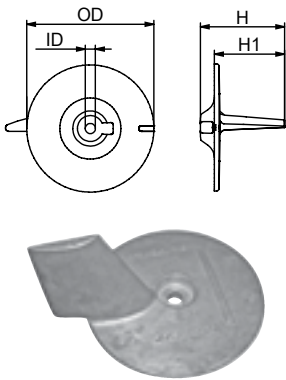

| | PID | LB | KG | | OD | H | H1 | ID | UPC |
|----|----------------|------|------|----|-----|-----|-----|------|-----------------|
| AL | CM41107ZW1B01A | 0.44 | 0.20 | mm | 112 | 75 | 62 | 9 | 6 28309 12726 8 |
| MG | CM41107ZW1B01M | 0.28 | 0.13 | | | | | | 6 28309 19292 1 |
| ZN | CM41107ZW1B01Z | 0.96 | 0.44 | in | 4.4 | 2.9 | 2.4 | 0.33 | 6 28309 19251 8 |

HONDA 75 - 90 - 115 -130 HP

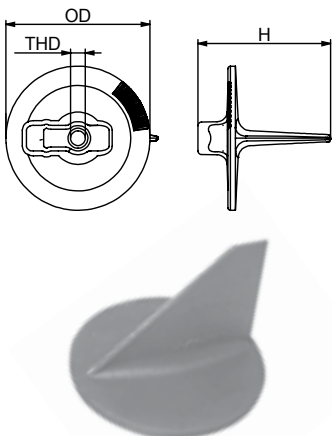

| | PID | LB | KG | | OD | H | THD | UPC |
|----|-----------------|------|------|----|-----|-----|------|-----------------|
| AL | CM411072ZW1003A | 0.46 | 0.21 | mm | 92 | 84 | 7/16 | 6 28309 24167 4 |
| MG | CM411072ZW1003M | 0.3 | 0.14 | | | | - 14 | 6 28309 24273 2 |
| ZN | CM411072ZW1003Z | 1 | 0.45 | in | 3.6 | 3.3 | UNC | 6 28309 24101 8 |

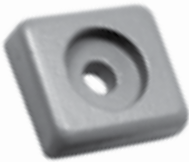
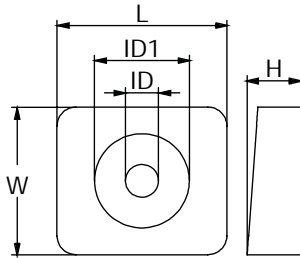
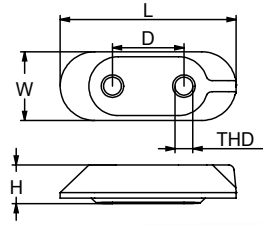
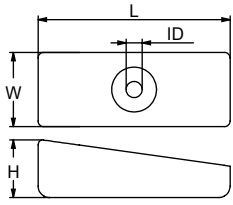

HONDA™ anodes

| | PID | LB | KG | | L | W | H | ID | UPC |
|----|----------------|------|------|----|-----|-----|-----|------|-----------------|
| AL | CM41109ZW1B00A | 0.25 | 0.11 | mm | 71 | 36 | 17 | 6 | 6 28309 12721 3 |
| MG | CM41109ZW1B00M | 0.17 | 0.09 | | | | | | 6 28309 17044 8 |
| ZN | CM41109ZW1B00Z | 0.49 | 0.22 | in | 2.8 | 1.4 | 0.7 | 0.24 | 6 28309 12735 0 |

HONDA 75 - 130 - 225 HP

| | PID | LB | KG | | L | W | H | D | THD | UPC |
|----|---------------|------|------|----|-----|----|-----|----|-----|-----------------|
| AL | CM6E04525111A | 0.09 | 0.04 | mm | 64 | 25 | 14 | 26 | M6 | 6 28309 12647 6 |
| MG | CM6E04525111M | 0.05 | 0.02 | | | | | | | 6 28309 12648 3 |
| ZN | CM6E04525111Z | 0.22 | 0.1 | in | 2.5 | 1 | 0.5 | 1 | | 6 28309 10069 8 |

| | PID | LB | KG | | L | W | H | ID | ID1 | UPC |
|----|----------------|------|------|----|-----|-----|-----|-----|-----|-----------------|
| AL | CM41106ZW9000A | 0.64 | 0.29 | mm | 32 | 28 | 10 | 6 | 18 | 6 28309 21151 6 |
| MG | CM41106ZW9000M | 0.44 | 0.20 | | | | | | | 6 28309 21172 1 |
| ZN | CM41106ZW9000Z | 2.19 | 0.99 | in | 1.3 | 1.1 | 0.4 | 0.2 | 0.7 | 6 28309 21127 1 |

HONDA 8 - 10 - 15 HP

HONDA™ anode kits

| | PID | LB | KG | Contains | Fits | UPC |
|----|----------------|------|------|--|--------------------------|-----------------|
| AL | CMHBF75115KITA | 1.76 | 0.8 | CM41107ZW1B01 X1 CM0641ZW1 X1 CM41109ZW1B00 X2 | Honda BF75- 90-115 | 6 28309 24953 3 |
| MG | CMHBF75115KITM | 1.31 | 0.59 | | | 6 28309 24954 0 |
| ZN | CMHBF75115KITZ | 4.27 | 1.94 | | | 6 28309 24955 7 |



ALL KITS INCLUDE FASTENING HARDWARE, INSTALLATION INSTRUCTIONS, AND ALL OF THE ANODES REQUIRED FOR 100% PROTECTION.

HONDA™ anode kits



| | PID | LB | KG | Contains | Fits | UPC |
|----|---------------|------|------|---|--------------------------------|-----------------|
| AL | CMHBF4050KITA | 1.17 | 0.53 | CM41107ZV500 X 1 CM06411ZV5 X 1 CM41109ZW1003 / CM826134 X 2 | Honda BF40-50HP OB-Motor | 6 28309 26007 1 |
| MG | CMHBF4050KITM | 0.79 | 0.36 | | | 6 28309 26029 3 |
| ZN | CMHBF4050KITZ | 2.66 | 1.21 | | | 6 28309 25983 9 |



| | PID | LB | KG | Contains | Fits | UPC |
|----|----------------|------|------|---|----------------------------|-----------------|
| AL | CMHBF35225KITA | 1.23 | 0.56 | CM41107ZV500 X 1 CM06411ZV5 X 1 CM41109ZW1003 / CM826134 X 2 CM5532187J00 X 2 | Honda BF35-225 Motor | 6 28309 26006 4 |
| MG | CMHBF35225KITM | 0.86 | 0.39 | | | 6 28309 26028 6 |
| ZN | CMHBF35225KITZ | 2.79 | 1.27 | | | 6 28309 25982 2 |

KAMEWA™ anodes

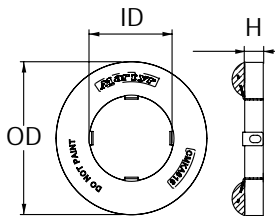
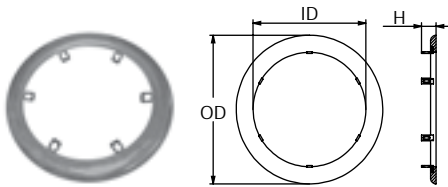

| | PID | LB | KG | | OD | ID | H | UPC |
|----|----------|------|------|----|------|------|------|-----------------|
| AL | CMKA614A | 6.19 | 2.81 | mm | 385 | 287 | 25 | 6 28309 21172 1 |
| MG | CMKA614M | 4.01 | 1.82 | in | 15.2 | 11.3 | 1 | 6 28309 23683 0 |
| ZN | CMKA614Z | 16 | 7.3 | | | | | 6 28309 23684 7 |
| AL | CMKA615A | 1.23 | 0.56 | mm | 160 | 106 | 50 | 6 28309 23685 4 |
| MG | CMKA615M | 0.86 | 0.39 | in | 6.3 | 4.2 | 1.97 | 6 28309 23686 1 |
| ZN | CMKA615Z | 2.86 | 1.3 | | | | | 6 28309 23687 8 |
| AL | CMKA616A | 2.45 | 1.11 | mm | 226 | 126 | 47 | 6 28309 23688 5 |
| MG | CMKA616M | 1.61 | 0.73 | in | 8.9 | 4.9 | 1.85 | 6 28309 23689 2 |
| ZN | CMKA616Z | 6.44 | 2.9 | | | | | 6 28309 23690 8 |

JET FF 375S - CLASS V2000

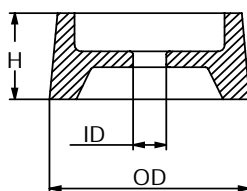

| | PID | LB | KG | | OD | ID | H | UPC |
|----|----------|------|------|----|------|------|------|-----------------|
| AL | CMKA617A | 0.35 | 0.16 | mm | 70 | 13 | 27 | 6 28309 23691 5 |
| MG | CMKA617M | 0.22 | 0.10 | in | 2.75 | 0.51 | 1.1 | 6 28309 23692 2 |
| ZN | CMKA617Z | 0.91 | 0.41 | | | | | 6 28309 23693 9 |
| ZN | CMKA730Z | 1.90 | 0.86 | mm | 79 | 17 | 42 | 6 28309 23711 0 |
| | | | | in | 3.11 | 0.67 | 1.65 | |

JET FF 375S - CLASS V2000

ALL KITS INCLUDE FASTENING HARDWARE, INSTALLATION INSTRUCTIONS, AND ALL OF THE ANODES REQUIRED FOR 100% PROTECTION.

KAMEWA™ anodes

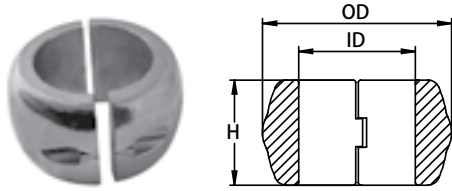

| | PID | LB | KG | | OD | ID | H | UPC |
|----|----------|------|------|----|------|------|------|-----------------|
| AL | CMKA618A | 0.62 | 0.28 | mm | 81 | 50 | 45 | 6 28309 23694 6 |
| MG | CMKA618M | 0.39 | 0.18 | | | | | 6 28309 23695 3 |
| ZN | CMKA618Z | 1.59 | 0.72 | in | 3.19 | 1.97 | 1.77 | 6 28309 22086 0 |
| AL | CMKA619A | 0.81 | 0.37 | mm | 93 | 60 | 48 | 6 28309 23697 7 |
| MG | CMKA619M | 0.53 | 0.24 | | | | | 6 28309 23698 4 |
| ZN | CMKA619Z | 2.09 | 0.95 | in | 3.66 | 2.36 | 1.89 | 6 28309 23699 1 |

A SERIES

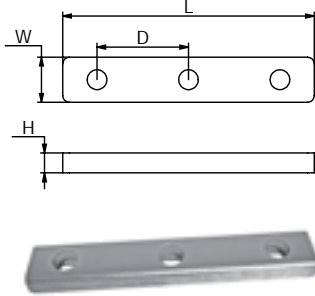

| | PID | LB | KG | | L | W | H | ID | UPC |
|----|----------|-------|-------|----|------|-----|-----|-----|-----------------|
| AL | CMKA620A | 4.91 | 2.23 | mm | 385 | 68 | 140 | 30 | 6 28309 22929 0 |
| MG | CMKA620M | 3.73 | 1.69 | | | | | | 6 28309 22960 3 |
| ZN | CMKA620Z | 10.14 | 4.60 | in | 15 | 2.7 | 5.5 | 1.2 | 6 28309 22927 6 |
| AL | CMKA621A | 10.54 | 4.78 | mm | 600 | 100 | 220 | 40 | 6 28309 23700 4 |
| MG | CMKA621M | 7.05 | 3.2 | | | | | | 6 28309 23701 1 |
| ZN | CMKA621Z | 29.32 | 13.30 | in | 23.6 | 3.9 | 8.6 | 1.6 | 6 28309 23702 8 |

KAMEWA TYPE

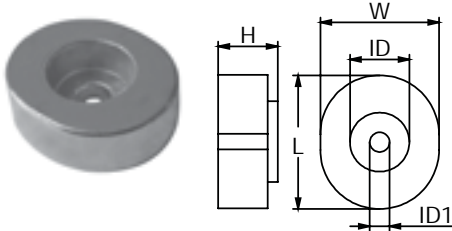

| | PID | LB | KG | | L | W | H | H1 | ID | ID1 | UPC |
|----|----------|-----|------|----|-----|-----|-----|----|-----|------|-----------------|
| ZN | CMKA622Z | 2.1 | 0.48 | mm | 68 | 60 | 27 | 25 | 32 | 12 | 6 28309 22087 7 |
| | | | | in | 2.7 | 2.4 | 1.1 | 1 | 1.3 | 0.48 | |

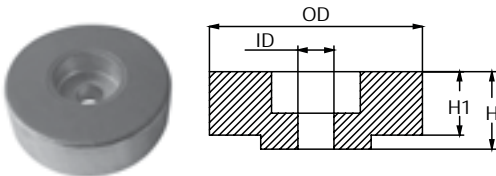

| | PID | LB | KG | | OD | ID | H | H1 | UPC |
|----|----------|------|------|----|----|------|------|-----|-----------------|
| ZN | CMKA623Z | 1.64 | 0.74 | mm | 77 | 12 | 25 | 23 | 6 28309 22088 4 |
| | | | | in | 3 | 0.48 | 0.98 | 0.9 | |

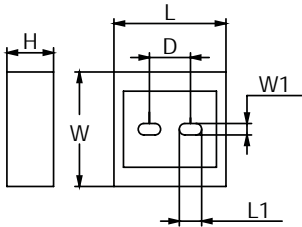

| | PID | LB | KG | | L | L1 | W | W1 | D | H | UPC |
|----|----------|------|-------|----|-----|------|-----|------|------|----|-----------------|
| AL | CMKA624A | 0.39 | 0.176 | mm | 60 | 12 | 60 | 7 | 18 | 25 | 6 28309 23067 8 |
| MG | CMKA624M | 0.24 | 0.112 | | | | | | | | 6 28309 23083 8 |
| ZN | CMKA624Z | 1 | 0.46 | in | 2.4 | 0.47 | 2.4 | 0.28 | 0.71 | 1 | 6 28309 23051 7 |

JET FF 375S - CLASS V2000

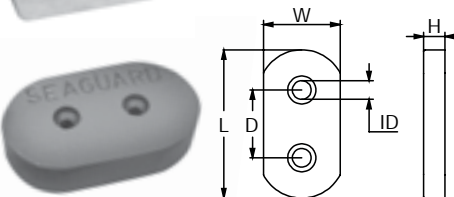

| | PID | LB | KG | | L | W | H | D | ID | UPC |
|----|----------|------|-----|----|-----|------|----|------|------|-----------------|
| ZN | SGPL573Z | 4.85 | 2.2 | mm | 175 | 90 | 25 | 80 | 13 | 6 28309 18292 2 |
| | | | | in | 6.9 | 3.54 | 1 | 3.15 | 0.51 | |

LOMBARDINI™ anodes

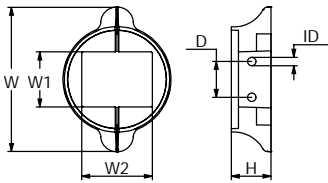

| | PID | LB | KG | | H | W | W1 | W2 | D | ID | UPC |
|----|------------|-------|-------|----|------|------|------|------|------|------|-----------------|
| AL | CM9135033A | 0.524 | 0.238 | mm | 33 | 121 | 46 | 59 | 30 | 7 | 6 28309 21162 2 |
| MG | CM9135033M | 0.330 | 0.150 | | | | | | | | 6 28309 21184 4 |
| ZN | CM9135033Z | 1.366 | 0.620 | in | 1.30 | 4.76 | 1.81 | 2.32 | 1.18 | 0.27 | 6 28309 21138 7 |
| AL | CM9135034A | 0.974 | 0.442 | mm | 33 | 152 | 46 | 59 | 30 | 7 | 6 28309 21163 9 |
| MG | CM9135034M | 0.617 | 0.280 | | | | | | | | 6 28309 21186 8 |
| ZN | CM9135034Z | 2.542 | 1.153 | in | 1.30 | 5.98 | 1.81 | 2.32 | 1.18 | 0.27 | 6 28309 21139 4 |

MERCURY MARINE™ anodes

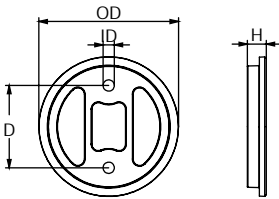

| | PID | LB | KG | | OD | ID | H | D | UPC |
|----|--------------|------|------|----|--------|-------|-------|------|-----------------|
| AL | CM847635001A | 0.85 | 0.39 | mm | 129.28 | 10.41 | 17.52 | 76.2 | 6 28309 25542 8 |
| MG | CM847635001M | 0.65 | 0.29 | | | | | | 6 28309 25547 3 |
| ZN | CM847635001Z | 2.22 | 1.01 | in | 5.09 | 0.41 | 0.69 | 3 | 6 28309 25537 4 |

Mercury Racing OB Trim; VERADO 350 CI - 6 CYLINDER - 4 TIMES

MERCURY™ OUTBOARD POWER TRIM anodes

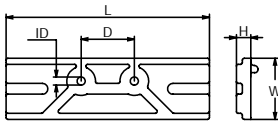

| | PID | LB | KG | | H | L | D | ID | W | UPC |
|----|--------------|------|------|----|------|------|-------|------|------|-----------------|
| AL | CM8M0057772A | 0.47 | 0.21 | mm | 12 | 170 | 44.45 | 6.8 | 51 | 6 28309 25035 5 |
| MG | CM8M0057772M | 0.30 | 0.13 | | | | | | | 6 28309 25036 2 |
| ZN | CM8M0057772Z | 1.23 | 0.56 | in | 0.47 | 6.69 | 1.75 | 0.26 | 2.01 | 6 28309 25034 8 |



MERCURY™ MERCUISER™ anodes

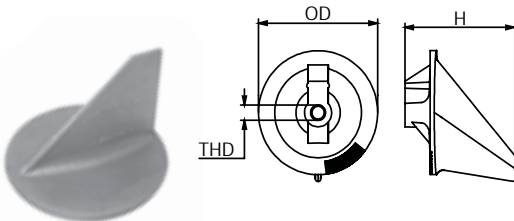

| | PID | LB | KG | | OD | H | THD | UPC |
|----|----------|------|------|----|-----|-----|---------------|-----------------|
| AL | CM31640A | 0.46 | 0.21 | mm | 92 | 84 | 7/16 - 14 UNC | 6 28309 11548 7 |
| MG | CM31640M | 0.3 | 0.14 | | | | | 6 28309 10010 0 |
| ZN | CM31640Z | 1.21 | 0.55 | in | 3.6 | 3.3 | | 6 28309 10011 7 |

MERCURY 50HP

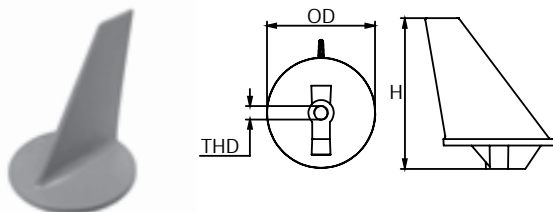

| | PID | LB | KG | | OD | H | THD | UPC |
|----|----------|------|------|----|-----|-----|---------------|-----------------|
| AL | CM34127A | 0.49 | 0.22 | mm | 89 | 127 | 7/16 - 14 UNC | 6 28309 12698 8 |
| MG | CM34127M | 0.32 | 0.15 | | | | | 6 28309 19284 6 |
| ZN | CM34127Z | 1.3 | 0.59 | in | 3.5 | 5 | | 6 28309 10019 3 |

MERCUISER 80 - 140 HP

MERCURY™ MERCUISER™ anodes

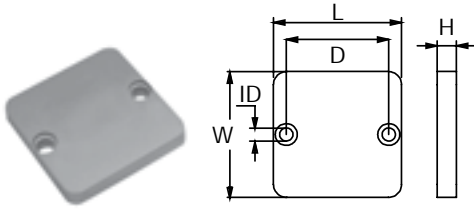

| | PID | LB | KG | | L | W | H | D | ID | UPC |
|----|----------|------|------|----|-----------------|-----|------|----|------|-----------------|
| AL | CM34762A | 0.2 | 0.09 | mm | 64 | 64 | 10 | 51 | 6 | 6 28309 12697 1 |
| MG | CM34762M | 0.13 | 0.06 | | 6 28309 19285 3 | | | | | |
| ZN | CM34762Z | 0.53 | 0.24 | in | 2.5 | 2.5 | 0.38 | 2 | 0.25 | 6 28309 10020 9 |

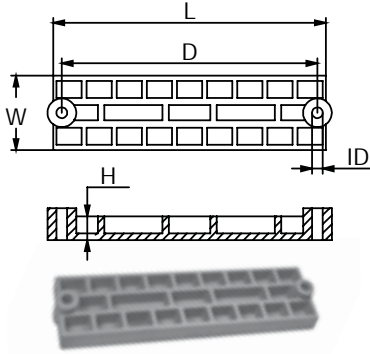

| | PID | LB | KG | | L | W | H | D | ID | UPA |
|----|----------|------|------|----|-----------------|----|-----|-----|------|-----------------|
| AL | CM43396A | 0.55 | 0.25 | mm | 192 | 52 | 17 | 178 | 7 | 6 28309 12694 0 |
| MG | CM43396M | 0.34 | 0.15 | | 6 28309 24275 6 | | | | | |
| ZN | CM43396Z | 1.45 | 0.66 | in | 7.56 | 2 | 0.6 | 7 | 0.29 | 6 28309 10051 3 |

MERCURY 25 HP /50/60/75 - MERCUISER E.B. 90 /
100 SINO 91 115/190 - SUPERAMERICA 80/115

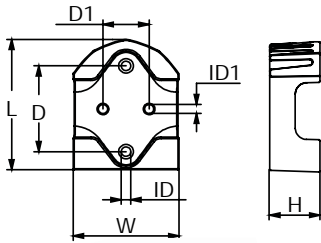

| | PID | LB | KG | | L | W | H | D | D1 | ID | ID1 | UPC |
|----|----------|------|------|----|-----------------|-----|-----|-----|------|------|------|-----------------|
| AL | CM43994A | 0.79 | 0.36 | mm | 101 | 79 | 38 | 66 | 35 | 7 | 7 | 6 28309 12696 4 |
| MG | CM43994M | 0.55 | 0.25 | | 6 28309 10053 7 | | | | | | | |
| ZN | CM43994Z | 2.09 | 0.95 | in | 4 | 3.1 | 1.5 | 2.6 | 1.36 | 0.28 | 0.26 | 6 28309 10054 4 |

MERCURY F.BB - MERCUISER E.B. / ALPHA GEN 2 + BRAVO

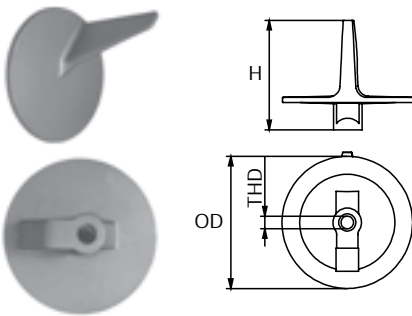

| | PID | LB | KG | | OD | H | THD | UPC |
|----|----------|------|------|----|-----------------|-----|------------------|-----------------|
| AL | CM46399A | 0.3 | 0.14 | mm | 92 | 84 | 7/16 - 14 UNC | 6 28309 12695 7 |
| MG | CM46399M | 0.2 | 0.09 | | 6 28309 19294 5 | | | |
| ZN | CM46399Z | 0.80 | 0.36 | in | 3.6 | 3.3 | | 6 28309 10055 1 |

50 - 140 HP

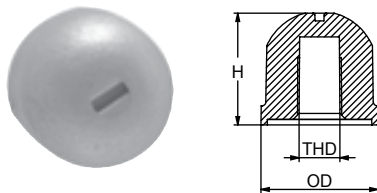

| | PID | LB | KG | | OD | H | THD | UPC |
|----|----------|------|------|----|-----------------|-----|--------------------|-----------------|
| AL | CM55989A | 0.09 | 0.04 | mm | 31 | 30 | 1/2 - 13 UNC | 6 28309 11540 1 |
| MG | CM55989M | 0.06 | 0.03 | | 6 28309 10061 2 | | | |
| ZN | CM55989Z | 0.24 | 0.11 | in | 1.2 | 1.2 | | 6 28309 10062 9 |

ALPHA ONE - BRAVO ONE

MERCURY™ MERCRUISER™ anodes

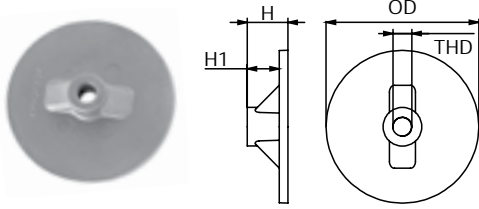

| | PID | LB | KG | | OD | H | H1 | THD | UPC |
|----|----------|------|------|----|------|------|------|------|-----------------|
| AL | CM76214A | 0.24 | 0.11 | mm | 90 | 24 | 19 | 7/16 | 6 28309 15937 5 |
| MG | CM76214M | 0.15 | 0.07 | | | | | - 14 | 6 28309 11323 0 |
| ZN | CM76214Z | 0.62 | 0.28 | in | 3.54 | 0.94 | 0.75 | UNC | 6 28309 10085 8 |

VERADO AND BRAVO

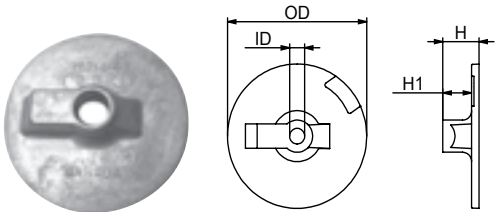

| | PID | LB | KG | | OD | ID | H | H1 | UPC |
|----|-----------|------|------|----|------|------|------|-----|-----------------|
| AL | CM762144A | 0.29 | 0.13 | mm | 92 | 24 | 19 | 13 | 6 28309 12316 1 |
| MG | CM762144M | 0.18 | 0.08 | | | | | | 6 28309 12314 7 |
| ZN | CM762144Z | 0.68 | 0.31 | in | 3.63 | 0.94 | 0.75 | 0.5 | 6 28309 12315 4 |

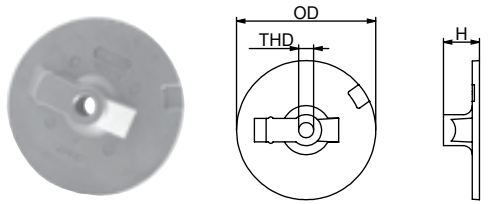

| | PID | LB | KG | | OD | H | THD | UPC |
|----|-----------|------|------|----|-----|-----|------|-----------------|
| AL | CM762145A | 0.29 | 0.13 | mm | 92 | 24 | 7/16 | 6 28309 11542 5 |
| MG | CM762145M | 0.17 | 0.08 | | | | - 14 | 6 28309 12310 9 |
| ZN | CM762145Z | 0.73 | 0.33 | in | 3.6 | 0.9 | UNC | 6 28309 11368 1 |

MERCURY ALPHA

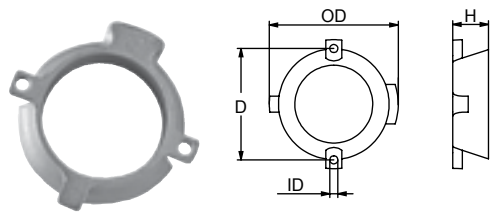

| | PID | LB | KG | | OD | ID | H | D | UPC |
|----|-----------|------|------|----|-----|-----|-----|-----|-----------------|
| AL | CM806105A | 0.2 | 0.09 | mm | 85 | 5 | 24 | 74 | 6 28309 11545 6 |
| MG | CM806105M | 0.13 | 0.06 | | | | | | 6 28309 11497 8 |
| ZN | CM806105Z | 0.5 | 0.02 | in | 3.3 | 0.2 | 0.9 | 2.9 | 6 28309 10089 6 |

MERCRUISER ALPHA ONE - ALPHA 2 GEN.

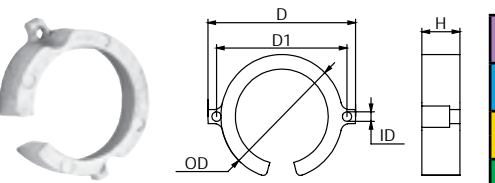

| | PID | LB | KG | | OD | ID | D | D1 | H | UPC |
|----|-----------|------|------|----|------|-----|-----|------|-----|-----------------|
| AL | CM806188A | 0.13 | 0.06 | mm | 70 | 5 | 84 | 74 | 23 | 6 28309 11537 1 |
| MG | CM806188M | 0.08 | 0.04 | | | | | | | 6 28309 12258 4 |
| ZN | CM806188Z | 0.33 | 0.15 | in | 2.75 | 0.2 | 3.3 | 2.91 | 0.9 | 6 28309 11520 3 |

BRAVO 1 AND BRAVO 3

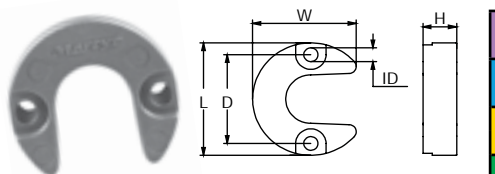

| | PID | LB | KG | | L | W | H | D | ID | UPC |
|----|-----------|------|------|----|-----|-----|-----|-----|-----|-----------------|
| AL | CM806189A | 0.09 | 0.04 | mm | 49 | 44 | 14 | 38 | 5 | 6 28309 11538 8 |
| MG | CM806189M | 0.06 | 0.03 | | | | | | | 6 28309 10095 7 |
| ZN | CM806189Z | 0.22 | 0.1 | in | 1.9 | 1.7 | 0.5 | 1.5 | 0.2 | 6 28309 10096 4 |

PISTONS MERCRUISER ALPHA

MERCURY™ MERCUISER™ anodes

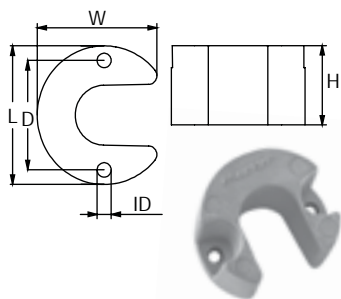

| | PID | LB | KG | | L | W | H | D | ID | UPC |
|----|-----------|------|------|----|----|-----|-----|-----|----|-----------------|
| AL | CM806190A | 0.3 | 0.14 | mm | 51 | 46 | 51 | 38 | 51 | 6 28309 11541 8 |
| MG | CM806190M | 0.19 | 0.09 | | | | | | | 6 28309 11496 1 |
| ZN | CM806190Z | 0.77 | 0.35 | in | 2 | 1.8 | 0.2 | 1.5 | 2 | 6 28309 10099 5 |

PISTONS MERCUISER BRAVO

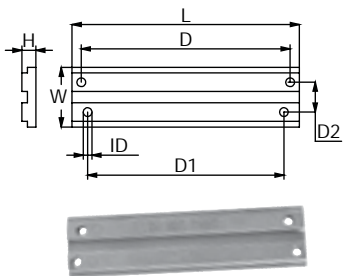

| | PID | LB | KG | | L | W | H | D | D1 | D2 | ID | UPC |
|----|-----------|------|------|----|------|------|------|------|------|------|------|-----------------|
| AL | CM818298A | 0.57 | 0.26 | mm | 194 | 51 | 12 | 178 | 167 | 25 | 7 | 6 28309 11547 0 |
| MG | CM818298M | 0.36 | 0.16 | | | | | | | | | 6 28309 12313 0 |
| ZN | CM818298Z | 1.45 | 0.66 | in | 7.62 | 2.00 | 0.47 | 7.00 | 6.58 | 1.00 | 0.27 | 6 28309 10020 9 |

40 HP A V6 135/ 150 /175 VERADO

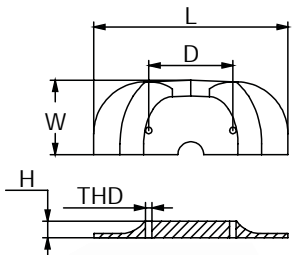

| | PID | LB | KG | | L | W | H | D | THD | UPC |
|----|------------|------|------|----|-----|------|------|-----------------|------------|-----------------|
| AL | CM821629CA | 0.66 | 0.3 | mm | 191 | 73 | 16 | 83 | ¼ - 20 UNC | 6 28309 11546 3 |
| MG | CM821629CM | 0.44 | 0.2 | | | | | 6 28309 11379 7 | | |
| ZN | CM821629CZ | 1.72 | 0.78 | in | 7.5 | 2.88 | 0.64 | 3.25 | | 6 28309 10110 7 |

ALPHA ONE - ALPHA 2 GEN.

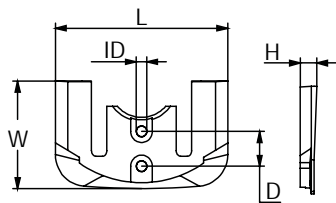

| | PID | LB | KG | | L | W | H | D | ID | UPC |
|----|-------------|------|------|----|-----|------|------|------|------|-----------------|
| AL | CM821630C2A | 0.86 | 0.39 | mm | 178 | 108 | 14 | 35 | 11 | 6 28309 11539 5 |
| MG | CM821630C2M | 0.57 | 0.26 | | | | | | | 6 28309 11498 5 |
| ZN | CM821630C2Z | 2.2 | 1 | in | 7 | 4.25 | 0.56 | 1.38 | 0.44 | 6 28309 10113 8 |

BRAVO 1 / 2 / 3

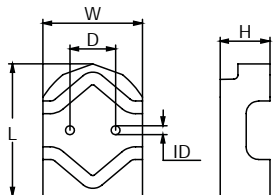

| | PID | LB | KG | | L | W | H | D | ID | UPC |
|----|-----------|------|------|----|-----|----|-----|------|------|-----------------|
| AL | CM821631A | 0.77 | 0.35 | mm | 102 | 76 | 38 | 35 | 7 | 6 28309 11549 4 |
| MG | CM821631M | 0.53 | 0.24 | | | | | | | 6 28309 10053 7 |
| ZN | CM821631Z | 1.96 | 0.89 | in | 4 | 3 | 1.5 | 1.38 | 0.27 | 6 28309 10054 4 |

MERCURY F.B.B. - MERCUISER E.B.



MERCURY™ MERCUISER™ anodes

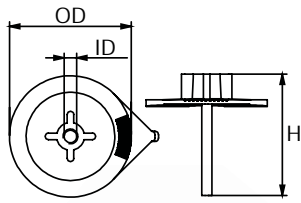

| | PID | LB | KG | | OD | ID | H | UPC |
|----|-------------|------|------|----|------|------|-----|-----------------|
| AL | CM822157C2A | 0.42 | 0.19 | mm | 93 | 9 | 82 | 6 28309 19598 4 |
| MG | CM822157C2M | 0.28 | 0.13 | | | | | 6 28309 19601 1 |
| ZN | CM822157C2Z | 1.06 | 0.48 | in | 3.65 | 0.36 | 3.2 | 6 28309 11371 1 |

F25- F50

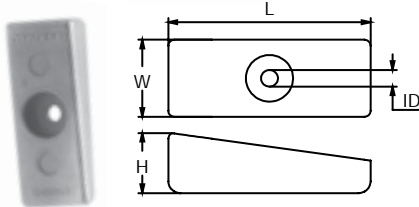

| | PID | LB | KG | | L | W | H | ID | UPC |
|----|-----------|------|------|----|----|------|-----|------|-----------------|
| AL | CM826134A | 0.22 | 0.1 | mm | 76 | 30 | 23 | 6 | 6 28309 11543 2 |
| MG | CM826134M | 0.15 | 0.07 | | | | | | 6 28309 12354 3 |
| ZN | CM826134Z | 0.56 | 0.25 | in | 3 | 1.16 | 0.9 | 0.25 | 6 28309 10123 7 |

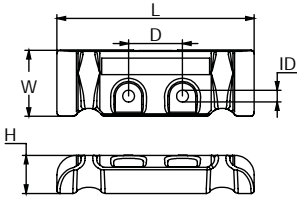

| | PID | LB | KG | | L | W | H | D | ID | UPC |
|----|-----------|------|------|----|-----|-----|----|-----|------|-----------------|
| AL | CM880653A | 0.44 | 0.2 | mm | 128 | 43 | 25 | 35 | 7 | 6 28309 12319 2 |
| MG | CM880653M | 0.28 | 0.13 | | | | | | | 6 28309 15989 4 |
| ZN | CM880653Z | 1.1 | 0.5 | in | 5 | 1.7 | 1 | 1.4 | 0.27 | 6 28309 12322 2 |

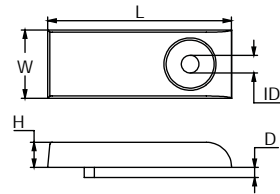

| | PID | LB | KG | | L | W | H | D | ID | UPC |
|----|-----------|------|------|----|-----|-----|-----|-----|------|-----------------|
| AL | CM892227A | 0.09 | 0.04 | mm | 74 | 27 | 10 | 4 | 7 | 6 28309 12321 5 |
| MG | CM892227M | 0.06 | 0.03 | | | | | | | 6 28309 12320 8 |
| ZN | CM892227Z | 0.23 | 0.1 | in | 2.9 | 1.1 | 0.4 | 0.2 | 0.26 | 6 28309 15990 0 |

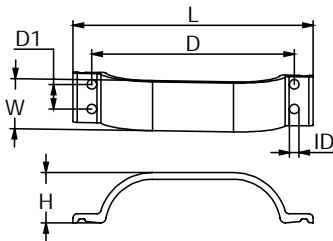

| | PID | LB | KG | | L | W | H | D | D1 | ID | UPC |
|----|----------|------|------|----|-----|-----|------|-----|------|------|-----------------|
| AL | CM89949A | 0.92 | 0.42 | mm | 280 | 59 | 60 | 239 | 29 | 12 | 6 28309 12579 0 |
| MG | CM89949M | 0.62 | 0.28 | | | | | | | | 6 28309 19302 7 |
| ZN | CM89949Z | 2.36 | 1.07 | in | 11 | 2.3 | 2.35 | 9.4 | 1.15 | 0.45 | 6 28309 11369 8 |

150 / 200 HP

MERCURY™ MERCUISER™ anodes

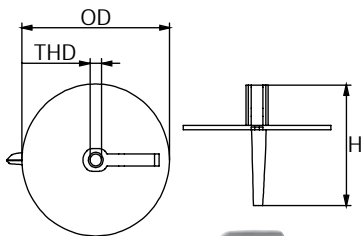

| | PID | LB | KG | | OD | H | THD | UPC |
|----|-----------|------|------|----|-----|------|-----|-----------------|
| AL | CM984325A | 0.36 | 0.16 | mm | 91 | 100 | M8 | 6 28309 12699 5 |
| MG | CM984325M | 0.24 | 0.11 | | | | | 6 28309 19303 4 |
| ZN | CM984325Z | 0.93 | 0.42 | in | 3.6 | 3.95 | | 6 28309 11519 7 |

AMERICA 25 HP (FROM 1990)

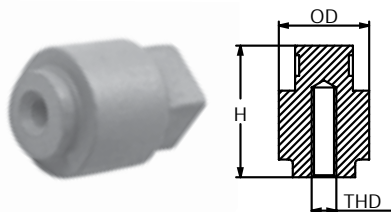

| | PID | LB | KG | | OD | H | THD | UPC |
|----|--------------|-------|-------|----|-----|-----|-----|-----------------|
| AL | CM804079002A | 0.053 | 0.024 | mm | 22 | 32 | M6 | 6 28309 21161 5 |
| MG | CM804079002M | 0.035 | 0.016 | | | | | 6 28309 21182 0 |
| ZN | CM804079002Z | 0.121 | 0.055 | in | 0.9 | 1.3 | | 6 28309 21137 0 |

YAMAHA 80 - 90 -100 -115 -200 - 225 -250 -300 HP

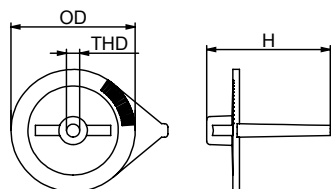

| | PID | LB | KG | | OD | H | THD | UPC |
|----|-----------|------|------|----|-----|-----|---------------------|-----------------|
| AL | CM822777A | 0.64 | 0.29 | mm | 90 | 83 | 7/16 - 14 UNC | 6 28309 24179 7 |
| MG | CM822777M | 0.39 | 0.18 | | | | | 6 28309 24289 3 |
| ZN | CM822777Z | 1.48 | 0.67 | in | 3.5 | 3.3 | | 6 28309 24112 4 |

35 HP - V6 MCM

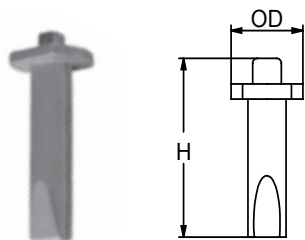

| | PID | LB | KG | | OD | H | UPC |
|----|------------|-------|-------|----|-----|-----|-----------------|
| AL | CM826887MA | 0.011 | 0.005 | mm | 16 | 40 | 6 28309 24180 3 |
| MG | CM826887MM | 0.006 | 0.003 | | | | 6 28309 24290 9 |
| ZN | CM826887MZ | 0.03 | 0.02 | in | 0.6 | 1.6 | 6 28309 24113 1 |

Also apply to Yamaha, Parsun

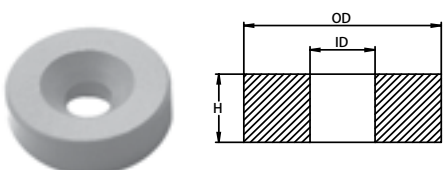

| | PID | LB | KG | | OD | H | ID | UPC |
|----|-----------|--------|-------|----|-------|------|------|-----------------|
| ZN | CM823912Z | 0.0308 | 0.014 | mm | 20.06 | 7.11 | 6.60 | 6 28309 23499 7 |
| | | | | in | 0.79 | 0.28 | 0.26 | |

MERCURY™ MERCRUISER™ anodes

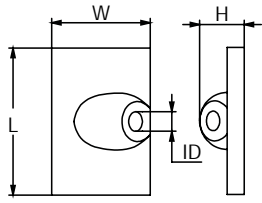

| | PID | LB | KG | | L | W | H | ID | UPC |
|----|----------|------|------|----|------|-----|------|------|-----------------|
| AL | CM42121A | 0.03 | 0.01 | mm | 42 | 29 | 11 | 7 | 6 28309 20954 4 |
| MG | CM42121M | 0.02 | 0.01 | | | | | | 6 28309 20975 9 |
| ZN | CM42121Z | 0.07 | 0.03 | in | 1.66 | 1.1 | 0.42 | 0.28 | 6 28309 20933 9 |

MERCURY 6-9.9 HP

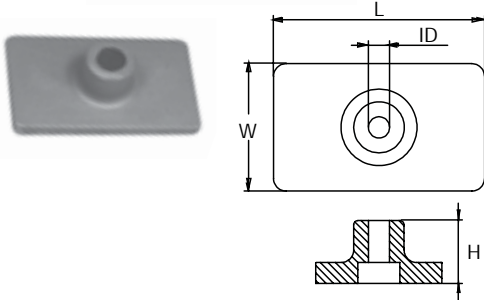

| | PID | LB | KG | | L | W | H | ID | UPC |
|----|------------|------|------|----|----|-----|-----|------|-----------------|
| AL | CM85824A3A | 0.02 | 0.01 | mm | 50 | 30 | 13 | 6 | 6 28309 23517 8 |
| MG | CM85824A3M | 0.02 | 0.01 | | | | | | 6 28309 23518 5 |
| ZN | CM85824A3Z | 0.08 | 0.04 | in | 2 | 1.2 | 0.5 | 0.25 | 6 28309 23519 2 |

MERCURY 4.5-9.9 HP

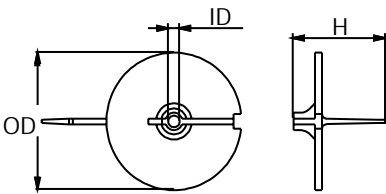

| | PID | LB | KG | | OD | ID | H | UPC |
|----|------------|------|------|----|-----|------|-----|-----------------|
| AL | CM94286T1A | 0.24 | 0.11 | mm | 95 | 9 | 65 | 6 28309 23523 9 |
| MG | CM94286T1M | 0.15 | 0.07 | | | | | 6 28309 23524 6 |
| ZN | CM94286T1Z | 0.62 | 0.28 | in | 3.7 | 0.33 | 2.6 | 6 28309 23525 3 |

OUTBOARD 25 HP

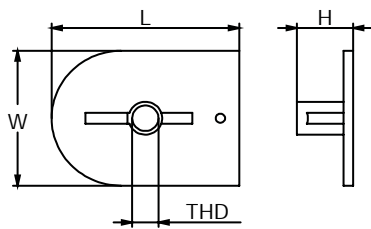

| | PID | LB | KG | | L | W | H | THD | UPC |
|----|------------|------|------|----|-----|-----|-----|------|-----------------|
| AL | CM47820A1A | 0.26 | 0.12 | mm | 100 | 74 | 30 | 5/16 | 6 28309 23350 1 |
| MG | CM47820A1M | 0.17 | 0.08 | | | | | - 18 | 6 28309 23351 8 |
| ZN | CM47820A1Z | 0.73 | 0.33 | in | 3.9 | 2.9 | 1.2 | UNC | 6 28309 23352 5 |

OUTBOARD 20 HP

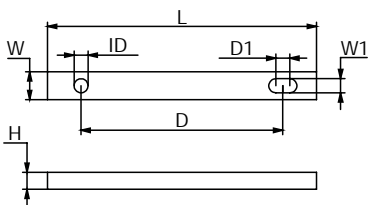

| | PID | LB | KG | | L | W | W1 | H | D | D1 | ID | UPC |
|----|-----------|------|------|----|-----|------|------|-----|------|------|------|-----------------|
| AL | CM825271Z | 0.25 | 0.11 | mm | 193 | 19 | 6 | 12 | 167 | 8 | 6 | 6 28309 20958 2 |
| MG | CM825271A | 0.16 | 0.07 | | | | | | | | | 6 28309 20979 7 |
| ZN | CM825271M | 0.65 | 0.29 | in | 7.6 | 0.75 | 0.25 | 0.5 | 6.58 | 0.32 | 0.25 | 6 28309 20937 7 |

25-30-40 HP 4T



MERCURY™ MERCRUISER™ anodes

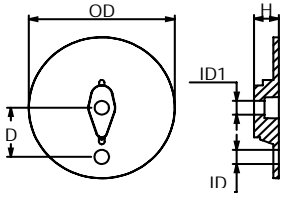

| | PID | LB | KG | | OD | ID | H | D | ID1 | UPC |
|----|------------|------|------|----|-----|------|-----|------|------|-----------------|
| AL | CM76214Q5A | 0.28 | 0.13 | mm | 112 | 11 | 19 | 39 | 11 | 6 28309 21160 8 |
| MG | CM76214Q5M | 0.17 | 0.08 | | | | | | | 6 28309 21181 3 |
| ZN | CM76214Q5Z | 0.73 | 0.33 | in | 4.4 | 0.43 | 0.7 | 1.54 | 0.43 | 6 28309 21136 3 |

BRAVO4 225-250 HP

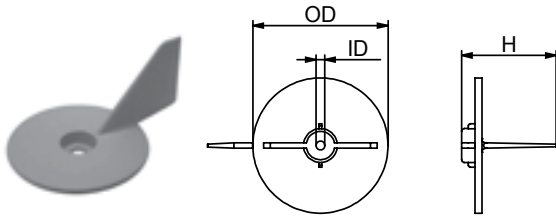

| | PID | LB | KG | | OD | ID | H | UPC |
|----|------------|----|------|----|-----|-----|-----|-----------------|
| ZN | CM17264C1Z | 1 | 0.46 | mm | 102 | 12 | 70 | 6 28309 17436 1 |
| | | | | in | 4 | 0.5 | 2.7 | |

FORMULA 60 HP

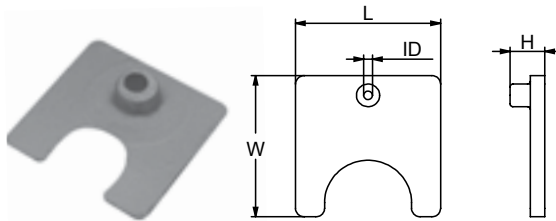

| | PID | LB | KG | | L | W | H | ID | UPC |
|----|----------|------|------|----|----|----|-----|------|-----------------|
| AL | CM09411A | 0.03 | 0.02 | mm | 50 | 50 | 12 | 7 | 6 28309 23323 5 |
| MG | CM09411M | 0.02 | 0.01 | | | | | | 6 28309 23324 2 |
| ZN | CM09411Z | 0.12 | 0.05 | in | 2 | 2 | 0.5 | 0.27 | 6 28309 23325 9 |

MERCURY 4,5-7 HP

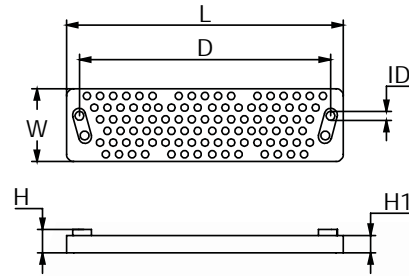

| | PID | LB | KG | | L | W | H | H1 | D | ID | UPC |
|----|------------|------|------|----|-----|------|------|------|------|-----|-----------------|
| AL | CM8239121A | 0.70 | 0.32 | mm | 190 | 50 | 20 | 16 | 7 | 178 | 6 28309 23494 2 |
| MG | CM8239121M | 0.44 | 0.20 | | | | | | | | 6 28309 23495 9 |
| ZN | CM8239121Z | 2 | 0.91 | in | 7.5 | 1.97 | 0.79 | 0.63 | 0.28 | 7 | 6 28309 23496 6 |

**MERCURY 50-75 HP MERCRUISER 90-100 HP
SUPER AMERICA 80-155 HP
NISSAN - TOHATSU 4,5 HP**



MERCRUISER™ ENHANCED PROTECTION prop nut

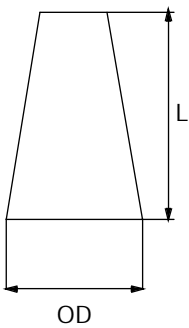

| | PID | LB | KG | | Shaft | L | OD | THD | Fastener | UPC |
|----|--------------|------|------|----|-------|------|------|--------------|---|-----------------|
| AL | CMPNDAF14UNS | 2.62 | 1.19 | mm | 25 | 78 | 54 | 1"-14 UNS | Fastener 5/16- 18x1 socket head w/ patch | 6 28309 12259 1 |
| MG | CMPNDMF14UNS | 1.69 | 0.77 | | | | | | | 6 28309 12264 5 |
| ZN | CMPNDZF14UNS | 6.75 | 3.07 | in | 1 | 3.06 | 2.12 | | | 6 28309 12231 7 |

FITS PROP SHAFTS FOR BRAVO III 2003 and Older



MERCURISER™ ENHANCED PROTECTION *prop nut*

| | PID | LB | KG | | Shaft | L | OD | THD | Fastener | UPC |
|----|------------------|------|------|----|-------|----|------|--------------|--|-----------------|
| AL | CMPNCAF16 | 0.78 | 0.35 | mm | 29 | 76 | 48 | 3/4" - UNF16 | Fastener 5/16- 18x1 socket head w/ patch | 6 28309 12373 4 |
| MG | CMPNCMF16 | 0.65 | 0.3 | | | | | | | 6 28309 11345 2 |
| ZN | CMPNCZF16 | 1.38 | 0.63 | in | 1.12 | 3 | 1.87 | | | 6 28309 10832 8 |

FITS PROP SHAFTS FOR ALPHA I & BRAVO I

| | PID | LB | KG | | Shaft | L | OD | THD | Fastener | UPC |
|----|------------------|------|------|----|-------|-----|------|-------------|---|-----------------|
| AL | CMPNEAF14 | 1.43 | 0.65 | mm | 35 | 89 | 60 | 1" - 14 UNS | Fastener 5/16-18x1 socket head w/ patch | 6 28309 12566 0 |
| MG | CMPNEMF14 | 1.2 | 0.54 | | | | | | | 6 28309 12054 2 |
| ZN | CMPNEZF14 | 2.5 | 1.14 | in | 1.37 | 3.5 | 2.37 | | | 6 28309 11510 4 |

FITS PROP SHAFTS FOR BRAVO II

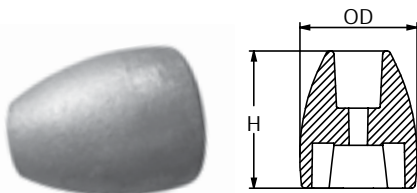

| | PID | LB | KG | | H | OD | Fastener | UPC |
|----|-------------------|------|------|----|-----|-----|----------------|-----------------|
| AL | CM865182CA | 0.42 | 0.19 | mm | 61 | 53 | 5/16- 18x1 1/2 | 6 28309 12329 1 |
| MG | CM865182CM | 0.27 | 0.12 | | | | | 6 28309 12344 4 |
| ZN | CM865182CZ | 1.12 | 0.51 | in | 2.4 | 2.1 | | 6 28309 12358 1 |

FITS PROP SHAFTS FOR BRAVO III 2004 to Present



MERCURY™ anode kits



| | PID | LB | KG | Contains | Fits | UPC |
|----|--------------------|------|-------|---|----------------|-----------------|
| AL | CMM3060KITA | 1.76 | 0.798 | CM17264C1 X 1 CM826134 X 2 CM818298 X 1 | F30-F40-F60 HP | 6 28309 26008 8 |
| MG | CMM3060KITM | 1.21 | 0.548 | | | 6 28309 26030 9 |
| ZN | CMM3060KITZ | 4.04 | 1.832 | | | 6 28309 25984 6 |



| | PID | LB | KG | Contains | Fits | UPC |
|----|---------------------|------|-------|---|----------------------|-----------------|
| AL | CMM75115KITA | 1.83 | 0.832 | CM818298 X 1 CM31640 X 1 CM826134 X 2 | 75-80-90-100- 115 HP | 6 28309 26009 5 |
| MG | CMM75115KITM | 1.31 | 0.594 | | | 6 28309 26031 6 |
| ZN | CMM75115KITZ | 4.19 | 1.9 | | | 6 28309 25985 3 |





MERCURY™ anode kits

| | PID | LB | KG | Contains | Fits | UPC |
|----|---------------|------|--------------|--------------|---------------------------------|-----------------|
| AL | CMVERADO4KITA | 1.72 | 0.78 | CM818298 X 1 | Verado 4 / OPTIMAX Engine | 6 28309 12272 0 |
| | | | CM826134 X 2 | | | |
| MG | CMVERADO4KITM | 1.23 | 0.56 | CM762145 X 1 | | 6 28309 16576 5 |



| | PID | LB | KG | Contains | Fits | UPC |
|----|---------------|------|--------------|--------------|--------------------|-----------------|
| AL | CMVERADO6KITA | 1.96 | 0.89 | CM880653 X 1 | Verado 6 Engine | 6 28309 12273 7 |
| | | | CM892227 X 4 | | | |
| MG | CMVERADO6KITM | 1.41 | 0.64 | CM826134 X 2 | | 6 28309 16577 2 |
| | | | CM762145 X 1 | | | |

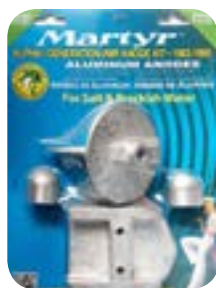

| | PID | LB | KG | Contains | Fits | UPC | |
|----|-----------------|------|------|-------------|--|-----------------|-----------------|
| AL | CMALPHAGEN1KITA | 1.41 | 0.64 | CM31640 X 1 | Alpha I Generation I Engine 1983 - 1990 | 6 28309 12807 4 | |
| MG | CMALPHAGEN1KITM | 0.95 | 0.43 | | | CM55989 X 2 | 6 28309 12808 1 |
| ZN | CMALPHAGEN1KITZ | 3.65 | 1.66 | | | CM821631 X 1 | 6 28309 12809 8 |



| | PID | LB | KG | Contains | Fits | UPC |
|----|-------------|------|------|--------------|--|-----------------|
| AL | CMALPHAKITA | 2.58 | 1.17 | CM762145 X 1 | Alpha I Generation II Engine 1991 - present | 6 28309 11552 4 |
| MG | CMALPHAKITM | 1.83 | 0.83 | CM806105 X 1 | | 6 28309 12263 8 |
| ZN | CMALPHAKITZ | 5.61 | 2.55 | CM821631 X 1 | | 6 28309 12611 7 |
| | | | | CM806189 X 2 | | |



| | PID | LB | KG | Contains | Fits | UPC |
|----|--------------|------|------|--------------|-------------------------------------|-----------------|
| AL | CMBRAVO1KITA | 2.44 | 1.11 | CM762145 X 1 | Bravo I Engine 1988 - present | 6 28309 11553 1 |
| MG | CMBRAVO1KITM | 1.82 | 0.83 | CM806188 X 1 | | 6 28309 12261 4 |
| ZN | CMBRAVO1KITZ | 5.35 | 2.43 | CM821630 X 1 | | 6 28309 12612 4 |
| | | | | CM806190 X 2 | | |

ALL KITS INCLUDE FASTENING HARDWARE, INSTALLATION INSTRUCTIONS, AND ALL OF THE ANODES REQUIRED FOR 100% PROTECTION.

MERCURY™ anode kits



| | PID | LB | KG | Contains | Fits | UPC |
|----|---------------|------|------|--|--|-----------------|
| AL | CMBRAVO23KITA | 2.31 | 1.05 | CM762145 X 1 CM821630 X 1 CM806190 X 2 | Bravo II 1989 - present & Bravo III 1989 - 2003 | 6 28309 11554 8 |
| MG | CMBRAVO23KITZ | 1.72 | 0.78 | | | 6 28309 12262 1 |
| ZN | CMBRAVO23KITM | 5.02 | 2.28 | | | 6 28309 12613 1 |



| | PID | LB | KG | Contains | Fits | UPC |
|----|--------------|------|------|---|--|-----------------|
| AL | CMBRAVO3KITA | 3.02 | 1.37 | CM762144 X 1 CM762145 X 1 CM865182C X 1 CM821630 X 1 CM806190 X 2 | Bravo III Engine 2004 - present | 6 28309 12473 1 |
| MG | CMBRAVO3KITZ | 2.16 | 0.98 | | | 6 28309 12578 3 |
| ZN | CMBRAVO3KITM | 6.57 | 2.98 | | | 6 28309 12614 8 |



| | PID | LB | KG | Fits | UPC |
|----|--------------|------|------|---|-----------------|
| AL | CM31640KITA | 0.62 | 0.28 | Alpha I Generation I Engine | 6 28309 12291 1 |
| MG | CM31640KITM | 0.5 | 0.23 | | 6 28309 12307 9 |
| AL | CM55989KITA | 0.36 | 0.16 | Alpha I Generation I Engine | 6 28309 12301 7 |
| MG | CM55989KITM | 0.3 | 0.14 | | 6 28309 12281 2 |
| AL | CM762144KITA | 0.49 | 0.22 | Bravo III Engine 2004 - present | 6 28309 12293 5 |
| MG | CM762144KITM | 0.38 | 0.17 | | 6 28309 12309 3 |
| AL | CM762145KITA | 0.5 | 0.23 | Alpha I Generation II Engine, Bravo I, Bravo II, Bravo III, Verado 4, 6 | 6 28309 12294 2 |
| MG | CM762145KITM | 0.37 | 0.17 | | 6 28309 11544 9 |
| AL | CM806105KITA | 0.38 | 0.17 | Alpha I Generation II Engine | 6 28309 12297 3 |
| MG | CM806105KITM | 0.31 | 0.14 | | 6 28309 12277 5 |
| AL | CM806188KITA | 0.13 | 0.06 | Bravo I 1988 - present | 6 28309 12298 0 |
| MG | CM806188KITM | 0.1 | 0.05 | | 6 28309 12278 2 |
| AL | CM806189KITA | 0.36 | 0.16 | Alpha I Generation II Engine | 6 28309 12295 9 |
| MG | CM806189KITM | 0.3 | 0.14 | | 6 28309 12305 5 |
| AL | CM806190KITA | 0.8 | 0.36 | Bravo I 1988 - present, Bravo II 1989 - present & Bravo III 1989 - 2003 | 6 28309 12296 6 |
| MG | CM806190KITM | 0.58 | 0.26 | | 6 28309 12306 2 |
| AL | CM818298KITA | 0.8 | 0.36 | Verado 4 /OPTIMAX Engine | 6 28309 12303 1 |
| MG | CM818298KITM | 0.58 | 0.26 | | 6 28309 12283 6 |
| AL | CM821629KITA | 0.88 | 0.4 | Alpha I Generation II Engine | 6 28309 12299 7 |
| MG | CM821629KITM | 0.66 | 0.3 | | 6 28309 12279 9 |
| AL | CM821630KITA | 1.08 | 0.49 | Bravo I 1988 - present, Bravo II 1989 - present & Bravo III 1989 - 2003 | 6 28309 12300 0 |
| MG | CM821630KITM | 0.79 | 0.36 | | 6 28309 12280 5 |
| AL | CM821631KITA | 1 | 0.45 | Alpha I Generation I Engine, Alpha I Generation II Engine | 6 28309 12292 8 |
| MG | CM821631KITM | 0.71 | 0.32 | | 6 28309 12308 6 |
| AL | CM821634KITA | 0.62 | 0.28 | Verado 4 /OPTIMAX Engine | 6 28309 12302 4 |
| MG | CM821634KITM | 0.46 | 0.21 | | 6 28309 12282 9 |
| AL | CM865182KITA | 0.74 | 0.28 | Bravo III Engine 2004 - present | 6 28309 12345 1 |
| MG | CM865182KITM | 0.59 | 0.27 | | 6 28309 12346 8 |

**ALL KITS INCLUDE FASTENING HARDWARE, INSTALLATION INSTRUCTIONS,
AND ALL OF THE ANODES REQUIRED FOR 100% PROTECTION.**

NISSAN™ TOHATSU™ anodes

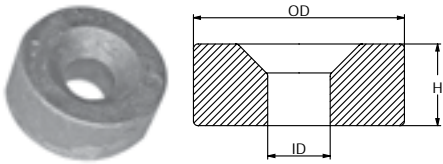

| | PID | LB | KG | | H | OD | ID | UPC |
|----|--------------|--------|--------|----|------|------|------|-----------------|
| AL | CM338602182A | 0.0149 | 0.0067 | mm | 22 | 6.5 | 8.5 | 6 28309 22961 0 |
| MG | CM338602182M | 0.0095 | 0.0043 | | | | | 6 28309 23165 1 |
| ZN | CM338602182Z | 0.0386 | 0.0175 | in | 0.86 | 0.25 | 0.33 | 6 28309 23140 8 |

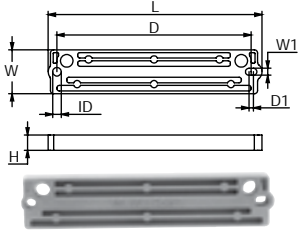

| | PID | LB | KG | | L | W | W1 | H | D | D1 | ID | UPC |
|----|--------------|------|------|----|-----|-----|------|-----|-----|------|------|-----------------|
| AL | CM3C7602181A | 0.46 | 0.21 | mm | 196 | 40 | 6 | 14 | 178 | 4 | 8 | 6 28309 24166 7 |
| MG | CM3C7602181M | 0.28 | 0.13 | | | | | | | | | 6 28309 24272 5 |
| ZN | CM3C7602181Z | 1.12 | 0.51 | in | 7.7 | 1.6 | 0.25 | 0.5 | 7 | 0.16 | 0.31 | 6 28309 24100 1 |

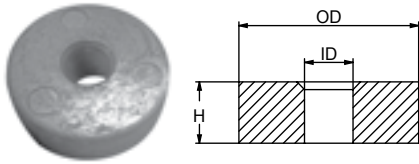

| | PID | LB | KG | | OD | ID | H | UPC |
|----|-----------------|------|------|----|-----|-----|-----|-----------------|
| AL | CM5338602182A0A | 0.02 | 0.01 | mm | 24 | 7 | 8 | 6 28309 17567 2 |
| MG | CM5338602182A0M | 0.01 | 0.01 | | | | | 6 28309 23924 4 |
| ZN | CM5338602182A0Z | 0.46 | 0.21 | in | 0.9 | 0.3 | 0.3 | 6 28309 17445 3 |

Also apply to Hidea

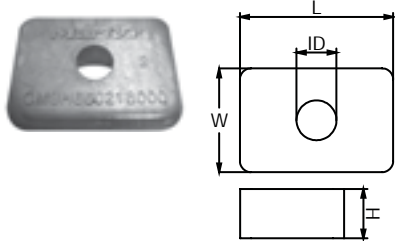

| | PID | LB | KG | | L | W | H | ID | UPC |
|----|----------------|------|------|----|-----|-----|-----|------|-----------------|
| AL | CM3H660218000A | 0.02 | 0.01 | mm | 28 | 19 | 9 | 6 | 6 28309 17442 2 |
| MG | CM3H660218000M | 0.01 | 0.01 | | | | | | 6 28309 18317 2 |
| ZN | CM3H660218000Z | 0.06 | 0.03 | in | 1.1 | 0.7 | 0.4 | 0.25 | 6 28309 17562 7 |

Also apply to Parsun & ShenFeng

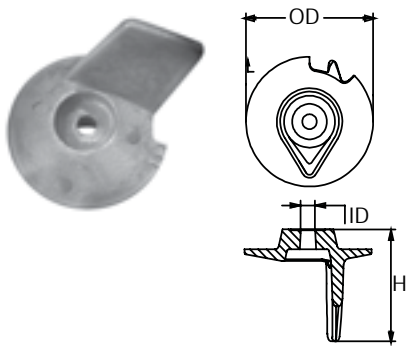

| | PID | LB | KG | | OD | ID | H | UPC |
|----|--------------|------|------|----|-----|------|-----|-----------------|
| AL | CM3V1602170A | 0.09 | 0.04 | mm | 55 | 6 | 48 | 6 28309 17563 4 |
| MG | CM3V1602170M | 0.06 | 0.03 | | | | | 6 28309 19290 7 |
| ZN | CM3V1602170Z | 0.22 | 0.1 | in | 2.2 | 0.25 | 1.9 | 6 28309 17443 9 |

140 HP
Also apply to Hidea

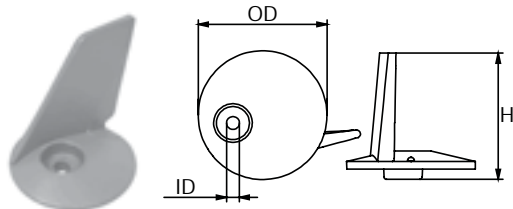

| | PID | LB | KG | | OD | ID | H | UPC |
|----|--------------|------|------|----|----|------|----|-----------------|
| AL | CM348602170A | 0.11 | 0.05 | mm | 50 | 6 | 50 | 6 28309 23153 8 |
| MG | CM348602170M | 0.06 | 0.03 | | | | | 6 28309 23167 5 |
| ZN | CM348602170Z | 0.28 | 0.13 | in | 2 | 0.25 | 2 | 6 28309 23141 5 |

FIN 25-40 HP

NISSAN™ TOHATSU™ anodes

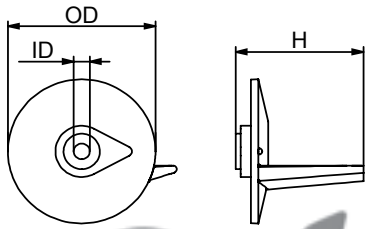

| | PID | LB | KG | | OD | ID | H | UPC |
|----|---------------|------|------|----|-----|------|----|-----------------|
| AL | CM3C86021700A | 0.13 | 0.06 | mm | 59 | 6 | 51 | 6 28309 21150 9 |
| MG | CM3C86021700M | 0.08 | 0.04 | | | | | 6 28309 21171 4 |
| ZN | CM3C86021700Z | 0.47 | 0.14 | in | 2.3 | 0.25 | 2 | 6 28309 21126 4 |

MEGA 25-50 HP

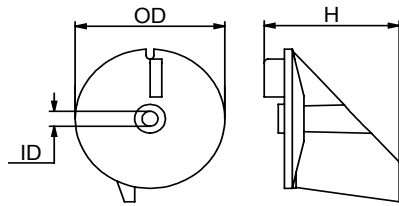

| | PID | LB | KG | | OD | ID | H | UPC |
|----|---------------|------|------|----|----|-----|------|-----------------|
| AL | CM3B76021700A | 0.31 | 0.14 | mm | 77 | 8 | 70 | 6 28309 21149 3 |
| MG | CM3B76021700M | 0.20 | 0.09 | | | | | 6 28309 21170 7 |
| ZN | CM3B76021700Z | 0.76 | 0.35 | in | 3 | 0.3 | 2.76 | 6 28309 21125 7 |

60-70-90-120-140 HP

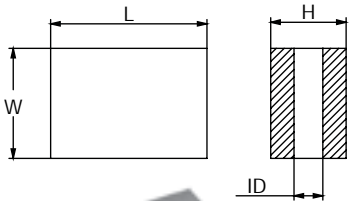

| | PID | LB | KG | | L | W | H | ID | UPC |
|----|--------------|-------|-------|----|-----|-----|-----|------|-----------------|
| AL | CM3B7602181A | 0.035 | 0.016 | mm | 27 | 19 | 13 | 7 | 6 28309 23154 5 |
| MG | CM3B7602181M | 0.02 | 0.01 | | | | | | 6 28309 23168 2 |
| ZN | CM3B7602181Z | 0.09 | 0.04 | in | 1.1 | 0.7 | 0.5 | 0.28 | 6 28309 23142 2 |

MEGA ENGINES

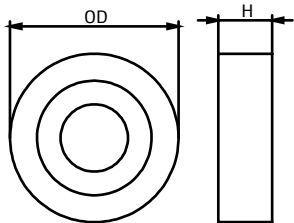

| | PID | LB | KG | | OD | H | UPC |
|----|--------------|------|------|----|----|-----|-----------------|
| ZN | CM369602181Z | 0.04 | 0.02 | mm | 25 | 8 | 6 28309 24099 8 |
| | | | | in | 1 | 0.3 | |

2.5-8 HP

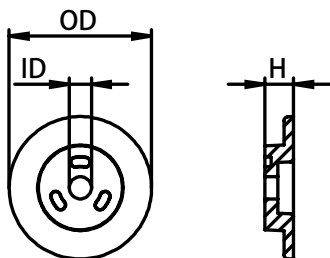

| | PID | LB | KG | | OD | ID | H | UPC |
|----|--------------|-----|------|----|-----|------|-----|-----------------|
| ZN | CM3M2602181Z | 0.1 | 0.05 | mm | 45 | 7 | 9 | 6 28309 23143 9 |
| | | | | in | 1.8 | 0.26 | 0.4 | |

40-140 HP

PAINIER™ anodes

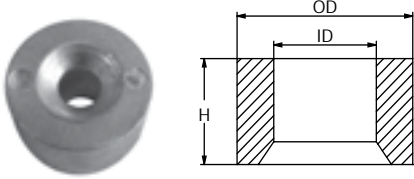

| | PID | LB | KG | | OD | ID | H | UPC |
|----|---------------|------|------|----|-----|-----|-----|-----------------|
| AL | CM6634525100A | 0.03 | 0.02 | mm | 24 | 7 | 14 | 6 28309 19531 1 |
| MG | CM6634525100M | 0.02 | 0.01 | | | | | 6 28309 19532 8 |
| ZN | CM6634525100Z | 0.09 | 0.04 | in | 0.9 | 0.3 | 0.6 | 6 28309 19533 5 |

YAMAHA 40 - 50 - 70 - 90 - HP UP TO 1987

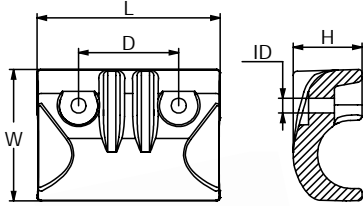

| | PID | LB | KG | | L | W | H | D | ID | UPC |
|----|---------------|------|------|----|-----|-----|-----|-----|-----|-----------------|
| AL | CM63D4525101A | 0.49 | 0.22 | mm | 86 | 62 | 32 | 47 | 7 | 6 28309 19528 1 |
| MG | CM63D4525101M | 0.31 | 0.14 | | | | | | | 6 28309 19529 8 |
| ZN | CM63D4525101Z | 1.28 | 0.58 | in | 3.4 | 2.4 | 1.3 | 1.9 | 0.3 | 6 28309 19530 4 |

YAMAHA 40 - 50 HP

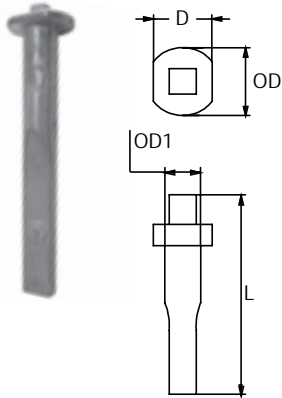

| | PID | LB | KG | | L | OD | OD1 | D | UPC |
|----|---------------|-------|-------|----|-----|-----|-----|-----|-----------------|
| AL | CM6H31132501A | 0.017 | 0.008 | mm | 68 | 16 | 8 | 13 | 6 28309 19534 2 |
| MG | CM6H31132501M | 0.011 | 5.005 | | | | | | 6 28309 19535 9 |
| ZN | CM6H31132501Z | 0.044 | 0.020 | in | 2.7 | 0.6 | 0.3 | 0.5 | 6 28309 19536 6 |

YAMAHA 200 - 225 - 250 HP UP TO 2003

PARSUN™ anodes

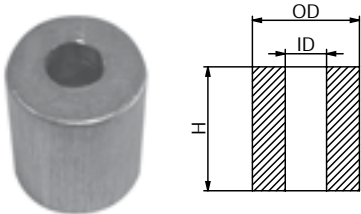

| | PID | LB | KG | | OD | ID | H | UPC |
|----|---------------|-------|-------|----|-----|-----|-----|-----------------|
| AL | CM6G81132500A | 0.011 | 0.005 | mm | 13 | 5 | 15 | 6 28309 23163 7 |
| MG | CM6G81132500M | 0.006 | 0.003 | | | | | 6 28309 23177 4 |
| ZN | CM6G81132500Z | 0.03 | 0.01 | in | 0.5 | 0.2 | 0.6 | 6 28309 23151 4 |

Also apply to YAMAHA 4 - 6 - 8 - 9 - 9,9 - 15 - 20 - 25 - 30 - 40 - 50 - 60 - 70 HP, ALLPASS, Hidea, Tiger & Painier

PARSUN™ anodes

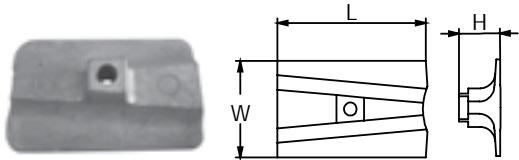

| | PID | LB | KG | | L | W | H | UPC |
|----|---------|-------|-------|----|-----|----|-----|-----|
| AL | CM8018A | 0.119 | 0.054 | mm | 80 | 50 | 22 | 3 |
| MG | CM8018M | 0.075 | 0.034 | | | | | 0 |
| ZN | CM8018Z | 0.311 | 0.141 | in | 3.1 | 2 | 0.9 | 7 |

Also apply to Yamaha

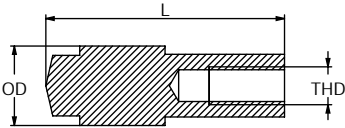

| | PID | LB | KG | | L | OD | THD | UPC |
|----|---------------|-------|-------|----|-----|-----|-----|-----|
| AL | CM66M1132500A | 0.011 | 0.005 | mm | 32 | 11 | 5 | 9 |
| MG | CM66M1132500M | 0.006 | 0.003 | | | | | 5 |
| ZN | CM66M1132500Z | 0.03 | 0.01 | in | 1.3 | 0.4 | 0.2 | 6 |

Also apply to YAMAHA 9,9 - 15 - 200 - 225 -250 - 300 HP, ALLPASS, Hidea & Tiger

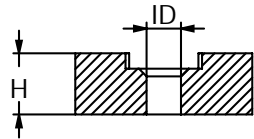
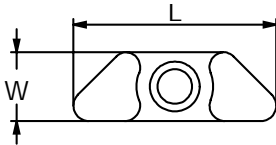

| | PID | LB | KG | | L | W | H | ID | UPC |
|----|---------------|-------|-------|----|-----|-----|-----|-----|-----|
| AL | CM6E51132500A | 0.02 | 0.01 | mm | 27 | 9 | 10 | 5 | 0 |
| MG | CM6E51132500M | 0.008 | 0.004 | | | | | | 7 |
| ZN | CM6E51132500Z | 0.004 | 0.002 | in | 1.1 | 0.4 | 0.4 | 0.2 | 7 |

Also apply to YAMAHA 6 - 9,9 - 15 -20 - 75 -90 - 115 - 130 - 150 - 175 - 200 - 225 - 250 - 300 - 350 HP, ALLPASS, Hidea, Tiger & Painier

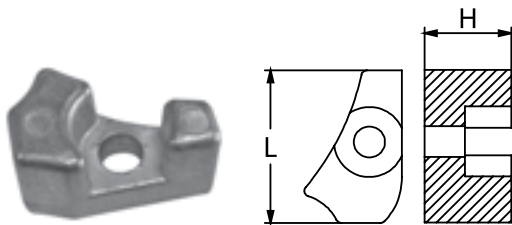

| | PID | LB | KG | | L | H | UPC |
|----|---------------|-------|-------|----|-----|-----|-----|
| AL | CM6821132500A | 0.008 | 0.004 | mm | 27 | 15 | 0 |
| MG | CM6821132500M | 0.006 | 0.003 | | | | 6 |
| ZN | CM6821132500Z | 0.04 | 0.02 | in | 1.1 | 0.6 | 7 |

YAMAHA 9,9 - 15 HP

Also apply to ALLPASS, Hidea, Tiger & Painier

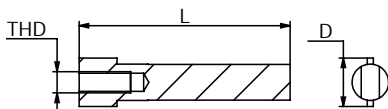

| | PID | LB | KG | | L | D | THD | UPC |
|----|---------------|-------|-------|----|-----|-----|-----|-----|
| AL | CM62Y1132500A | 0.013 | 0.006 | mm | 49 | 11 | 5 | 2 |
| MG | CM62Y1132500M | 0.009 | 0.004 | | | | | 8 |
| ZN | CM62Y1132500Z | 0.035 | 0.016 | in | 1.9 | 0.4 | 0.2 | 3 |

Also apply to YAMAHA 25 - 30 - 40 -50 - 60 -70 - 150 - 175 - 200 - 225 -250 HP

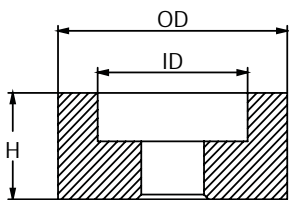

PARSUN™ anodes

| | PID | LB | KG | | OD | ID | H | UPC |
|----|---------------|------|-------|----|----|-----|-----|-----------------|
| AL | CM6764525100A | 0.02 | 0.009 | mm | 25 | 11 | 7 | 6 28309 23158 3 |
| MG | CM6764525100M | 0.14 | 0.006 | | | | | 6 28309 23172 9 |
| ZN | CM6764525100Z | 0.05 | 0.026 | in | 1 | 0.4 | 0.3 | 6 28309 23146 0 |

Also apply to Yamaha, ALLPASS, Hidea, Tiger & Painier

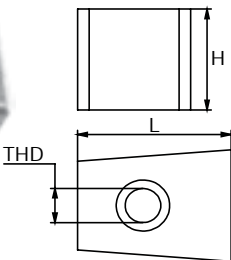

| | PID | LB | KG | | L | H | THD | UPC |
|----|---------------|------|------|----|-----|-----|-----|-----------------|
| AL | CM67C4525100A | 0.1 | 0.04 | mm | 35 | 23 | 8 | 6 28309 20957 5 |
| MG | CM67C4525100M | 0.07 | 0.03 | | | | | 6 28309 20978 0 |
| ZN | CM67C4525100Z | 0.27 | 0.12 | in | 1.4 | 0.9 | 0.3 | 6 28309 20936 0 |

Also apply to Yamaha, ALLPASS, Hidea, Tiger & Painier

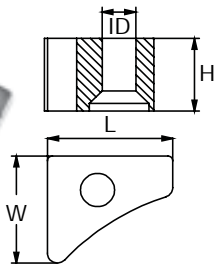

| | PID | LB | KG | | L | W | H | ID | UPC |
|----|---------------|------|-------|----|----|-----|-----|-----|-----------------|
| AL | CM6761132500A | 0.02 | 0.011 | mm | 25 | 22 | 15 | 7 | 6 28309 23157 6 |
| MG | CM6761132500M | 0.01 | 0.007 | | | | | | 6 28309 23171 2 |
| ZN | CM6761132500Z | 0.06 | 0.028 | in | 1 | 0.9 | 0.6 | 0.3 | 6 28309 23145 3 |

YAMAHA 40 HP

Also apply to Hidea, Tiger & Painier

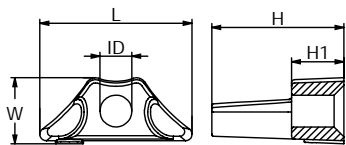

| | PID | LB | KG | | L | W | H | H1 | ID | UPC |
|----|---------------|--------|-------|----|-----|-----|-----|-----|-----|-----------------|
| AL | CM6881132500A | 0.006 | 0.003 | mm | 23 | 10 | 20 | 8 | 5 | 6 28309 23160 6 |
| MG | CM6881132500M | 0.004 | 0.002 | | | | | | | 6 28309 23174 3 |
| ZN | CM6881132500Z | 0.0019 | 0.009 | in | 0.9 | 0.4 | 0.8 | 0.3 | 0.2 | 6 28309 23148 4 |

Also apply to YAMAHA 40 - 50 - 75 - 80 - 85 - 90 HP

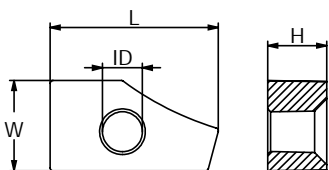

| | PID | LB | KG | | L | W | H | ID | UPC |
|----|---------------|-------|-------|----|-----|------|------|------|-----------------|
| AL | CM6891132500A | 0.013 | 0.006 | mm | 28 | 15 | 10 | 6 | 6 28309 23161 3 |
| MG | CM6891132500M | 0.008 | 0.004 | | | | | | 6 28309 23175 0 |
| ZN | CM6891132500Z | 0.039 | 0.018 | in | 1.1 | 0.59 | 0.39 | 0.24 | 6 28309 23148 4 |

Also apply to Yamaha 25 - 30 HP UP TO 1997, ALLPASS, Hidea & Painier

RENAULT™ anodes



NUT FOR SHAFT

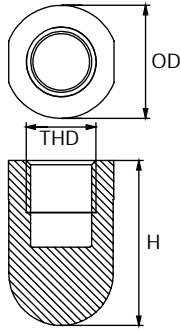

| | PID | LB | KG | | OD | H | THD | UPC |
|----|---------|------|------|-----------------|-----|-----|-----|-----------------|
| AL | CMRE16A | 0.07 | 0.03 | mm | 26 | 38 | M16 | 6 28309 20970 4 |
| MG | CMRE16M | 0.04 | 0.02 | | | | | 6 28309 20991 9 |
| ZN | CMRE16Z | 0.19 | 0.09 | in | 1 | 1.5 | | 6 28309 20949 0 |
| AL | CMRE20A | 0.13 | 0.06 | | | | mm | 35 |
| MG | CMRE20M | 0.09 | 0.04 | 6 28309 20992 6 | | | | |
| ZN | CMRE20Z | 0.35 | 0.16 | in | 1.4 | 2 | | |

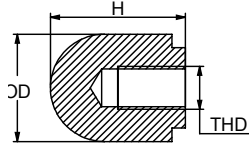
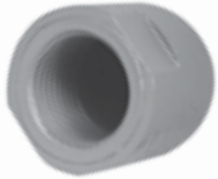

| | PID | LB | KG | | OD | H | THD | UPC |
|----|---------|------|------|----|-----|-----|-------------|-----------------|
| AL | CMRE28A | 0.18 | 0.08 | mm | 40 | 49 | M28 x2.5 | 6 28309 20972 8 |
| MG | CMRE28M | 0.11 | 0.05 | | | | | 6 28309 20993 3 |
| ZN | CMRE28Z | 0.49 | 0.22 | in | 1.6 | 1.9 | | 6 28309 20951 3 |

NUT FOR SHAFT

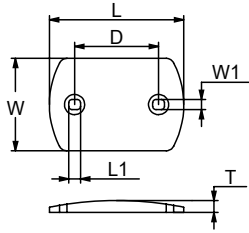

| | PID | LB | KG | | L | L1 | W | W1 | D | T | UPC |
|----|---------|------|------|----|-----|------|----|------|------|------|-----------------|
| ZN | CMRE50Z | 0.37 | 0.17 | mm | 80 | 8 | 50 | 6 | 48 | 10 | 6 28309 23785 1 |
| | | | | in | 3.1 | 0.32 | 2 | 0.25 | 1.89 | 0.39 | |



SEASALL™ ENGINE anodes



| | PID | LB | KG | | L | L1 | OD | OD1 | UPC |
|----|-----------|-------|-------|----|------|------|------|------|-----------------|
| ZN | CMHS1760Z | 0.231 | 0.105 | mm | 70 | 10 | 17 | 14 | 6 28309 25565 7 |
| | | | | in | 2.75 | 0.39 | 0.67 | 0.55 | |

ANODE ONLY

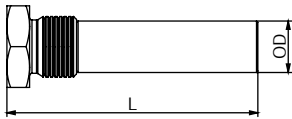

| | PID | LB | KG | | L | OD | UPC |
|----|------------|-------|-------|----|------|------|-----------------|
| ZN | CMHS1760PZ | 0.349 | 0.159 | mm | 83 | 17 | 6 28309 25564 0 |
| | | | | in | 3.27 | 0.67 | |

W/PLUG

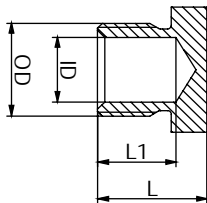

| | PID | LB | KG | | ID | OD | L | L1 | UPC |
|----|------------|-------|-------|----|------|------------|------|------|-----------------|
| ZN | CMEPHS1420 | 0.118 | 0.054 | mm | 14 | M20 X15 | 23 | 16.5 | 6 28309 25566 4 |
| | | | | in | 0.55 | | 0.90 | 0.65 | |

W/ BRASS PLUG

SELVA™ anodes

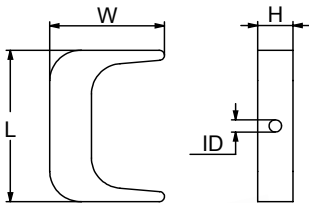
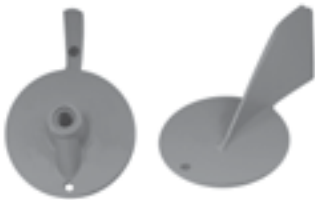
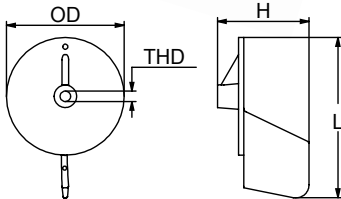
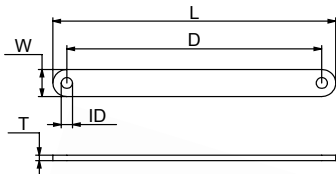
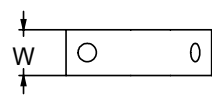
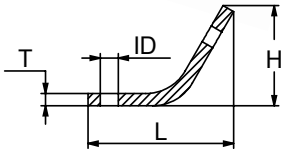
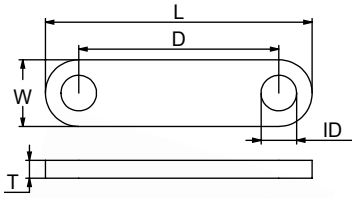

| | PID | LB | KG | | L | W | D | ID | T | UPC |
|----|------------|------|------|----|-----|-----|----|------|-----|-----------------|
| ZN | CM9005655Z | 0.05 | 0.02 | mm | 60 | 15 | 51 | 4 | 4 | 6 28309 23200 9 |
| | | | | in | 2.4 | 0.6 | 2 | 0.17 | 0.2 | |

PIATTA FB SERIES

| | PID | LB | KG | | L | W | H | ID | T | UPC |
|----|------------|------|------|----|----|-----|-----|------|------|-----------------|
| ZN | CM9005660Z | 0.06 | 0.03 | mm | 52 | 15 | 28 | 4 | 4 | 6 28309 23201 6 |
| | | | | in | 2 | 0.6 | 1.1 | 0.17 | 0.16 | |

FB SERIES CURVE

| | PID | LB | KG | | L | W | D | ID | T | UPC |
|----|------------|------|------|----|-----|-----|-----|------|-----|-----------------|
| ZN | CM9005665Z | 0.24 | 0.11 | mm | 203 | 20 | 183 | 7 | 4 | 6 28309 23202 3 |
| | | | | in | 8 | 0.8 | 7.2 | 0.26 | 0.2 | |

| | PID | LB | KG | | L | H | OD | THD | UPC |
|----|------------|------|------|----|-----|-----|------|-----|-----------------|
| ZN | CM2500050Z | 0.45 | 0.20 | mm | 90 | 70 | 59 | M8 | 6 28309 23190 3 |
| | | | | in | 3.5 | 2.7 | 2.32 | | |

BEST 800-S1000

| | PID | LB | KG | | L | W | H | UPC |
|----|------------|------|------|----|-----|-----|-----|-----------------|
| ZN | CM2504020Z | 0.46 | 0.21 | mm | 75 | 55 | 17 | 6 28309 23193 4 |
| | | | | in | 2.9 | 2.2 | 0.7 | |
| ZN | CM2504025Z | 0.31 | 0.14 | mm | 88 | 53 | 11 | 6 28309 23194 1 |
| | | | | in | 3.5 | 2.1 | 0.4 | |
| ZN | CM2504035Z | 0.22 | 0.1 | mm | 60 | 40 | 12 | 6 28309 23195 8 |
| | | | | in | 2.4 | 1.6 | 0.5 | |

S405-S700

100 HP

**80 HP
IZIMIR 8 CV
NAXOS 15 CV**

SELVA™ anodes

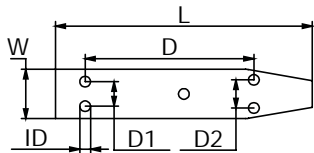

| | PID | LB | KG | | L | W | H | D | ID | D1 | D2 | UPC |
|----|------------|------|-----|----|-----|-----|-----|------|------|------|------|-----------------|
| ZN | CM2500010Z | 0.22 | 0.1 | mm | 143 | 28 | 35 | 65 | 4 | 18 | 16 | 6 28309 23189 7 |
| | | | | in | 5.6 | 1.1 | 1.4 | 2.56 | 0.17 | 0.71 | 0.63 | |

6-15 HP

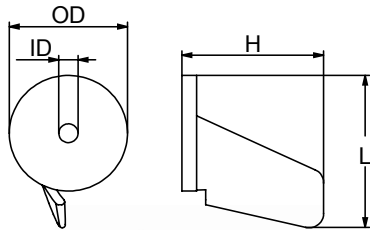

| | PID | LB | KG | | L | OD | ID | H | UPC |
|----|------------|------|-----|----|------|-----|------|-----|-----------------|
| ZN | CM2500065Z | 0.22 | 0.1 | mm | 47 | 40 | 7 | 48 | 6 28309 23191 0 |
| | | | | in | 1.85 | 1.6 | 0.26 | 1.9 | |

25-40 HP

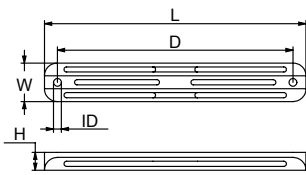

| | PID | LB | KG | | L | W | H | D | ID | UPC |
|----|------------|------|------|----|-----|-----|-----|-----|------|-----------------|
| ZN | CM2504015Z | 0.86 | 0.39 | mm | 200 | 30 | 14 | 182 | 6 | 6 28309 23192 7 |
| | | | | in | 7.9 | 1.2 | 0.5 | 7.1 | 0.25 | |

S600 SERIES

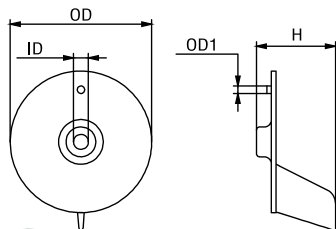

| | PID | LB | KG | | OD | OD1 | ID | H | UPC |
|----|-----------|------|-----|----|-----|------|------|-----|-----------------|
| ZN | CM82795MZ | 0.43 | 0.2 | mm | 95 | 5 | 9 | 53 | 6 28309 20938 4 |
| | | | | in | 3.7 | 0.19 | 0.33 | 2.1 | |

YAMAHA 25-30 HP, MANTA / BARRACUDA

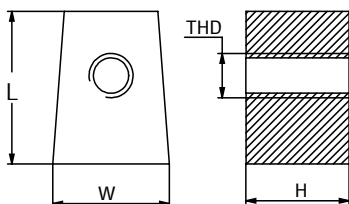

| | PID | LB | KG | | L | W | H | THD | UPC |
|----|---------------|------|------|----|------|----|------|------|-----------------|
| ZN | CM67C4525100Z | 0.25 | 0.12 | mm | 35 | 27 | 24 | M8 x | 6 28309 20936 0 |
| | | | | in | 1.36 | 1 | 0.93 | 1.25 | |

YAMAHA T25 - F30 - F40 - F50 - F60 HP



SUZUKI™ anodes

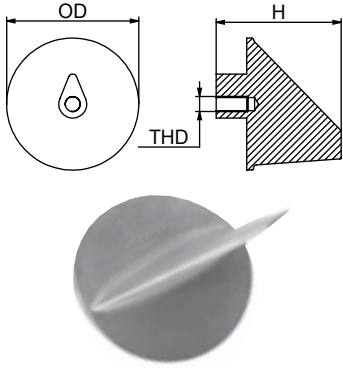

| | PID | LB | KG | | OD | H | THD | UPC |
|----|---------------|------|------|----|-----|-----|------------------|-----------------|
| AL | CM5512587D00A | 0.3 | 0.14 | mm | 89 | 84 | M10 x 1.25 | 6 28309 24171 1 |
| MG | CM5512587D00M | 0.19 | 0.09 | | | | | 6 28309 24279 4 |
| ZN | CM5512587D00Z | 0.75 | 0.34 | in | 3.5 | 3.3 | | 6 28309 10057 5 |

SUZUKI 50 - 70 HP DT150 - DT175 - DT200 - DT225 4 T

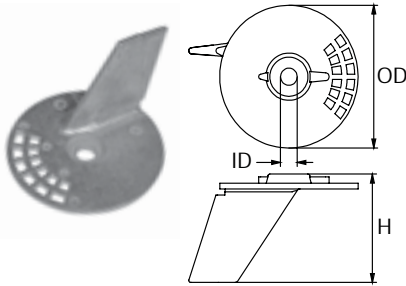

| | PID | LB | KG | | OD | ID | H | UPC |
|----|--------------|------|------|----|-----|-----|-----|-----------------|
| AL | CM551259630A | 0.15 | 0.07 | mm | 70 | 8 | 53 | 6 28309 19258 7 |
| MG | CM551259630M | 0.07 | 0.03 | | | | | 6 28309 19295 2 |
| ZN | CM551259630Z | 0.28 | 0.13 | in | 2.7 | 0.3 | 2.1 | 6 28309 10058 2 |

DF60 - DF70

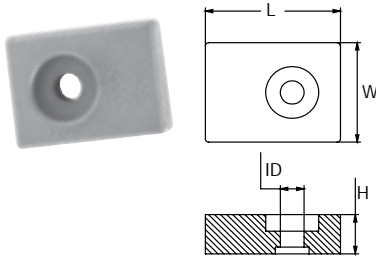

| | PID | LB | KG | | L | W | H | ID | UPC |
|----|---------------|------|------|----|-----|-----|-----|------|-----------------|
| AL | CM5532095310A | 0.07 | 0.03 | mm | 40 | 30 | 12 | 7 | 6 28309 19259 4 |
| MG | CM5532095310M | 0.04 | 0.02 | | | | | | 6 28309 19296 9 |
| ZN | CM5532095310Z | 0.17 | 0.08 | in | 1.6 | 1.2 | 0.5 | 0.26 | 6 28309 10059 9 |

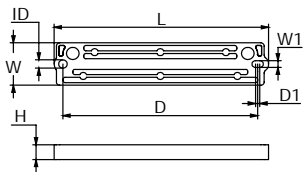

| | PID | LB | KG | | L | W | W1 | H | D | D1 | ID | UPC |
|----|---------------|------|------|----|-----|-----|------|-----|-----|------|------|-----------------|
| AL | CM5532194900A | 0.46 | 0.21 | mm | 196 | 40 | 6 | 14 | 178 | 4 | 8 | 6 28309 24173 5 |
| MG | CM5532194900M | 0.28 | 0.13 | | | | | | | | | 6 28309 24282 4 |
| ZN | CM5532194900Z | 1.12 | 0.51 | in | 7.7 | 1.6 | 0.25 | 0.5 | 7 | 0.16 | 0.31 | 6 28309 24106 3 |

70 - 90 - 115 - 140 - 150 CV. Also fits BRP™ & Mercury™

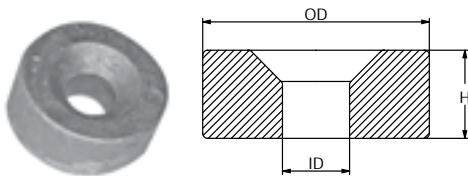

| | PID | LB | KG | | OD | ID | H | UPC |
|----|---------------|--------|--------|----|------|------|------|-----------------|
| AL | CM1113094600A | 0.0149 | 0.0067 | mm | 22 | 6.5 | 8.5 | 6 28309 20952 0 |
| MG | CM1113094600M | 0.0095 | 0.0043 | | | | | 6 28309 20973 5 |
| ZN | CM1113094600Z | 0.0386 | 0.0175 | in | 0.86 | 0.25 | 0.33 | 6 28309 20931 5 |

**YAMAHA 40 HP UP TO 1997
SUZUKI FB**

SUZUKI™ anodes

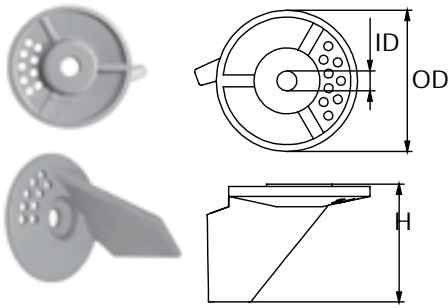

| | PID | LB | KG | | OD | ID | H | UPC |
|----|---------------|------|------|----|-----|------|----|-----------------|
| AL | CM5512595301A | 0.12 | 0.06 | mm | 60 | 8 | 50 | 6 28309 20955 1 |
| MG | CM5512595301M | 0.08 | 0.04 | | | | | 6 28309 20976 6 |
| ZN | CM5512595301Z | 0.31 | 0.14 | in | 2.4 | 0.33 | 2 | 6 28309 20934 6 |

SUZUKI 55-65 HP

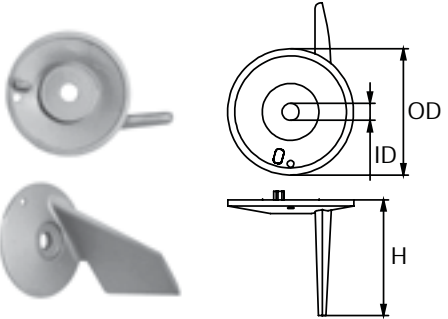

| | PID | LB | KG | | OD | H | ID | UPC |
|----|---------------|------|------|----|-----|------|------|-----------------|
| ZN | CM5512595500Z | 0.35 | 0.16 | mm | 62 | 57 | 9 | 6 28309 21129 5 |
| | | | | in | 2.4 | 2.24 | 0.33 | |

75-85 HP

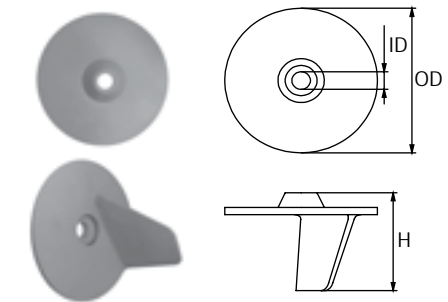

| | PID | LB | KG | | OD | ID | H | UPC |
|----|---------------|------|------|----|-----|------|-----|-----------------|
| AL | CM5512594502A | 0.26 | 0.12 | mm | 99 | 11 | 67 | 6 28309 23359 4 |
| MG | CM5512594502M | 0.15 | 0.07 | | | | | 6 28309 23360 0 |
| ZN | CM5512594502Z | 0.72 | 0.33 | in | 3.9 | 0.44 | 2.6 | 6 28309 23361 7 |

SUZUKI 115 HP

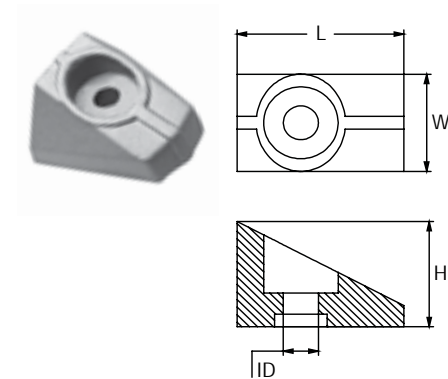

| | PID | LB | KG | | L | OD | ID | H | UPC |
|----|---------------|------|-----|----|-----|-----|------|------|-----------------|
| ZN | CM5532098600Z | 0.22 | 0.1 | mm | 38 | 23 | 21 | 6 | 6 28309 23367 9 |
| | | | | in | 1.5 | 0.9 | 0.83 | 0.25 | |

OUTBOARD
SUZUKI FB

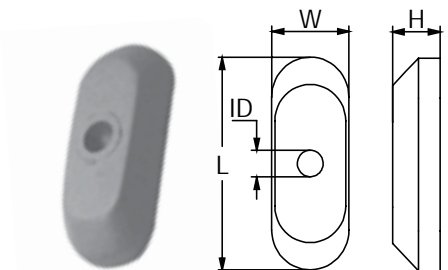

| | PID | LB | KG | | L | W | H | ID | UPC |
|----|---------------|------|------|----|-----|-----|-----|-----|-----------------|
| AL | CM5532098400A | 0.04 | 0.02 | mm | 48 | 18 | 11 | 6 | 6 28309 21154 7 |
| MG | CM5532098400M | 0.02 | 0.01 | | | | | | 6 28309 21175 2 |
| ZN | CM5532098400Z | 0.11 | 0.05 | in | 1.9 | 0.7 | 0.4 | 0.2 | 6 28309 21130 1 |

SUZUKI 2 HP

SUZUKI™ anodes

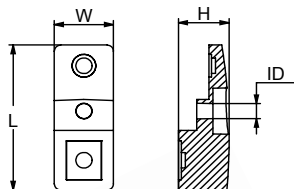

| | PID | LB | KG | | L | W | H | ID | UPC |
|----|---------------|------|------|----|-----|-----|-----|-----|-----------------|
| AL | CM5532190J01A | 0.08 | 0.03 | mm | 55 | 22 | 19 | 6 | 6 28309 21155 4 |
| MG | CM5532190J01M | 0.04 | 0.02 | | | | | | 6 28309 21176 9 |
| ZN | CM5532190J01Z | 0.19 | 0.09 | in | 2.2 | 0.9 | 0.7 | 0.2 | 6 28309 21131 8 |

DF 90 - 115 -140

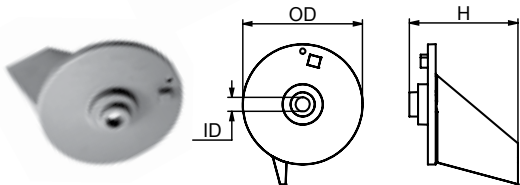

| | PID | LB | KG | | OD | H | ID | UPC |
|----|---------------|-------|-------|----|-----|-----|------|-----------------|
| AL | CM5512587E01A | 0.191 | 0.087 | mm | 73 | 66 | 9 | 6 28309 24172 8 |
| MG | CM5512587E01M | 0.123 | 0.056 | | | | | 6 28309 24280 0 |
| ZN | CM5512587E01Z | 0.54 | 0.25 | in | 2.9 | 2.6 | 0.33 | 6 28309 24105 6 |

70-90-115-140 HP

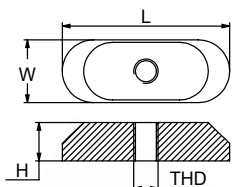

| | PID | LB | KG | | L | W | H | THD | UPC |
|----|---------------|------|------|----|-----|-----|-----|--------|-----------------|
| AL | CM4181198500A | 0.04 | 0.02 | mm | 48 | 18 | 11 | M6 x 1 | 6 28309 23213 9 |
| MG | CM4181198500M | 0.02 | 0.01 | | | | | | 6 28309 23227 6 |
| ZN | CM4181198500Z | 0.11 | 0.05 | in | 1.9 | 0.7 | 0.4 | | 6 28309 23196 5 |

2.2-4 HP

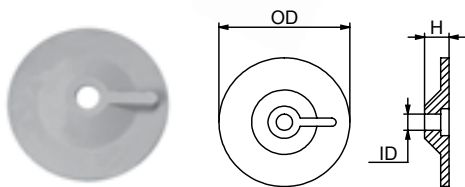

| | PID | LB | KG | | OD | H | ID | UPC |
|----|---------------|------|------|----|-----|-----|------|-----------------|
| AL | CM5532193900A | 0.05 | 0.02 | mm | 48 | 9 | 7 | 6 28309 20956 8 |
| MG | CM5532193900M | 0.03 | 0.01 | | | | | 6 28309 20935 3 |
| ZN | CM5532193900Z | 0.12 | 0.05 | in | 1.9 | 0.4 | 0.26 | 6 28309 20977 3 |

9.9-15 HP 4T

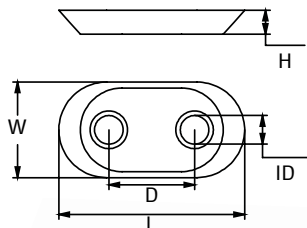

| | PID | LB | KG | | L | W | H | D | ID | UPC |
|----|---------------|------|-------|----|-----|------|-----|-----|------|-----------------|
| AL | CM5530095500A | 0.05 | 0.023 | mm | 78 | 20 | 10 | 40 | 7 | 6 28309 23927 5 |
| MG | CM5530095500M | 0.04 | 0.019 | | | | | | | 6 28309 23928 2 |
| ZN | CM5530095500Z | 0.17 | 0.08 | in | 3.1 | 0.79 | 0.4 | 1.6 | 0.26 | 6 28309 23926 8 |

2-8 HP

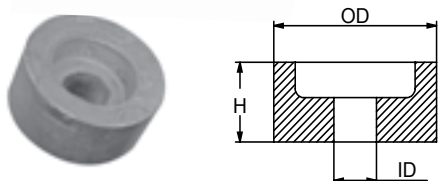

| | PID | LB | KG | | OD | H | ID | UPC |
|----|---------------|------|------|----|------|------|------|-----------------|
| ZN | CM5532187J00Z | 0.04 | 0.02 | mm | 21 | 10 | 6 | 6 28309 19252 5 |
| | | | | in | 0.83 | 0.39 | 0.24 | |

ENGINES 3,5 - 5 - 6 HP 4T

SUZUKI™ anode kits



| | PID | LB | KG | Contains | Fits | UPC |
|----|---------------|------|------|---|---------------------------------|-----------------|
| AL | CMSZ90140KITA | 0.85 | 0.38 | CM5532190J01 X 1 CM5532187J00 X 4 CM3C7602181A0 X 1 | Suzuki 90-100-115 -140 HP | 6 28309 24962 5 |
| MG | CMSZ90140KITM | 0.59 | 0.27 | | | 6 28309 24963 2 |
| ZN | CMSZ90140KITZ | 1.72 | 0.78 | | | 6 28309 24964 9 |



| | PID | LB | KG | Contains | Fits | UPC |
|----|--------------|------|------|--|--------------------|-----------------|
| AL | CMSZ4050KITA | 0.86 | 0.39 | CM5532095310 X 2 CM5532187J00 X 4 CM5512595500 X 1 | Suzuki 40-50 HP | 6 28309 24967 0 |
| MG | CMSZ4050KITM | 0.67 | 0.30 | | | 6 28309 24968 7 |
| ZN | CMSZ4050KITZ | 1.19 | 0.54 | | | 6 28309 24969 4 |

ALL KITS INCLUDE FASTENING HARDWARE, INSTALLATION INSTRUCTIONS, AND ALL OF THE ANODES REQUIRED FOR 100% PROTECTION.

VOLVO PENTA™ anodes

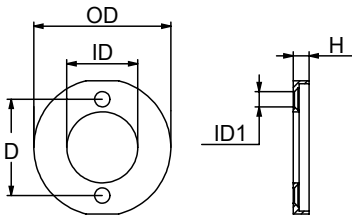

| | PID | LB | KG | | OD | D | ID | ID1 | H | UPC |
|----|--------------------|------|------|----|-----|------|----|------|-----|-----------------|
| AL | CMV15A (CM875810A) | 0.19 | 0.09 | mm | 99 | 67 | 51 | 11 | 11 | 6 28309 12355 0 |
| MG | CMV15M (CM875810M) | 0.11 | 0.05 | | | | | | | 6 28309 19320 1 |
| ZN | CMV15Z (CM875810Z) | 0.43 | 0.2 | in | 3.9 | 2.74 | 2 | 0.43 | 0.4 | 6 28309 10360 6 |

50-100 SERIES

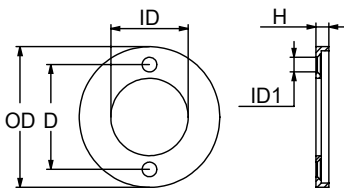

| | PID | LB | KG | | OD | D | ID | ID1 | H | UPC |
|----|--------------------|------|------|----|-----|-----|-----|------|-----|-----------------|
| AL | CMV16A (CM875809A) | 0.19 | 0.09 | mm | 106 | 79 | 58 | 11 | 10 | 6 28309 12356 7 |
| MG | CMV16M (CM875809M) | 0.11 | 0.05 | | | | | | | 6 28309 19321 8 |
| ZN | CMV16Z (CM875809Z) | 0.44 | 0.2 | in | 4.2 | 3.1 | 2.3 | 0.43 | 0.4 | 6 28309 10361 3 |

50-200 SERIES



VOLVO PENTA™ anodes

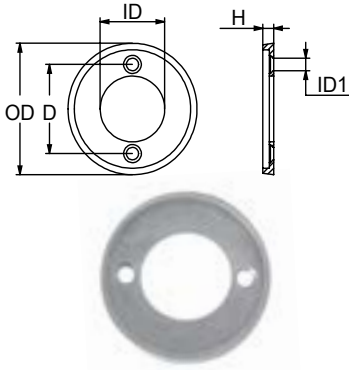

| | PID | LB | KG | | OD | D | ID | ID1 | H | UPC |
|----|-------------------------|------|------|----|-----|-----|-----|------|-----|-----------------|
| AL | CMV17A (CM875806-4A) | 0.29 | 0.13 | mm | 117 | 79 | 58 | 11 | 10 | 6 28309 12357 4 |
| MG | CMV17M (CM875806-4M) | 0.16 | 0.07 | | | | | | | 6 28309 19322 5 |
| ZN | CMV17Z (CM875806-4Z) | 0.65 | 0.29 | in | 4.6 | 3.1 | 2.3 | 0.43 | 0.4 | 6 28309 10362 0 |

50-250-270-275-280-285 SERIES

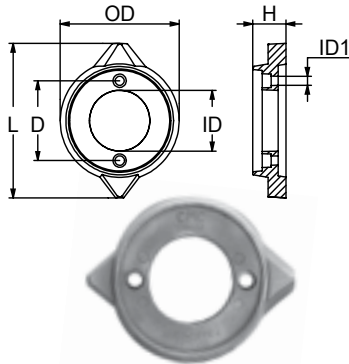

| | PID | LB | KG | | L | H | D | OD | ID | ID1 | UPC |
|----|-------------------------|------|------|----|-----|------|------|-----|-----|------|-----------------|
| AL | CMV18A (CM875815-3A) | 0.64 | 0.29 | mm | 155 | 34 | 80 | 120 | 61 | 9 | 6 28309 12266 9 |
| MG | CMV18M (CM875815-3M) | 0.4 | 0.18 | | | | | | | | 6 28309 10364 4 |
| ZN | CMV18Z (CM875815-3Z) | 1.16 | 0.73 | in | 6.1 | 1.34 | 3.15 | 4.7 | 2.4 | 0.35 | 6 28309 10363 7 |

280-290 E SINGLE DROP SERIES

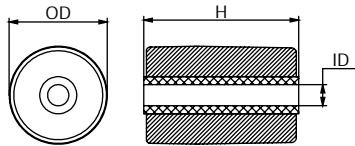

| | PID | LB | KG | | OD | H | ID | UPC |
|----|-------------|------|------|----|------|------|------|-----------------|
| AL | CM21718129A | 0.46 | 0.21 | mm | 38.9 | 61.5 | 8.3 | 6 28309 25162 8 |
| MG | CM21718129M | 0.34 | 0.15 | | | | | 6 28309 25163 5 |
| ZN | CM21718129Z | 1.02 | 0.46 | in | 1.53 | 2.42 | 0.33 | 6 28309 25161 1 |

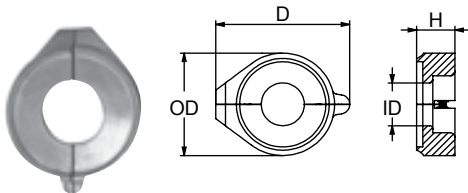

| | PID | LB | KG | | D | OD | ID | H | UPC |
|----|-----------|------|------|----|------|------|------|------|-----------------|
| AL | CM358407A | 1.43 | 0.65 | mm | 139 | 108 | 45 | 40 | 6 28309 12394 9 |
| MG | CM358407M | 0.89 | 0.41 | | | | | | 6 28309 12404 5 |
| ZN | CM358407Z | 3.27 | 1.48 | in | 5.47 | 4.25 | 1.77 | 1.57 | 6 28309 12325 3 |

SD 130/150 2002 2003 SERIES

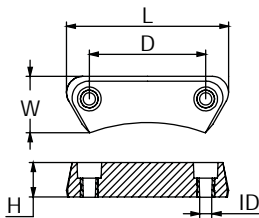

| | PID | LB | KG | | L | W | H | D | ID | UPC |
|----|------------|------|------|----|-----|-----|----|-----|------|-----------------|
| AL | CM3588745A | 0.45 | 0.20 | mm | 118 | 41 | 25 | 85 | 9 | 6 28309 17066 0 |
| MG | CM3588745M | 0.45 | 0.20 | | | | | | | 6 28309 17067 7 |
| ZN | CM3588745Z | 1.08 | 0.49 | in | 4.6 | 1.6 | 1 | 3.4 | 0.35 | 6 28309 17068 4 |

DUO PROP



VOLVO PENTA™ anodes

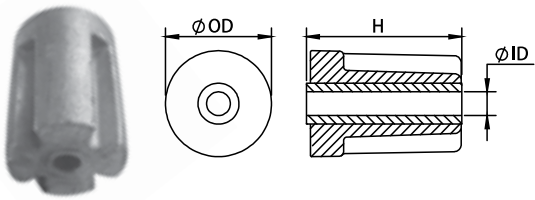

| | PID | LB | KG | | OD | ID | H | UPC |
|----|------------|------|------|----|------|------|------|-----------------|
| AL | CM3593881A | 0.75 | 0.34 | mm | 49.1 | 10.5 | 72 | 6 28309 17069 1 |
| MG | CM3593881M | 0.57 | 0.26 | | | | | 6 28309 19286 0 |
| ZN | CM3593881Z | 1.61 | 0.73 | in | 1.93 | 0.41 | 2.83 | 6 28309 17070 7 |

IPS

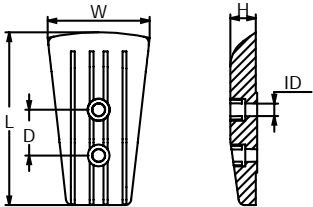

| | PID | LB | KG | | L | H | W | D | ID | UPC |
|----|------------|------|------|----|-------|------|------|------|------|-----------------|
| AL | CM3589875A | 0.72 | 0.33 | mm | 132.3 | 19.6 | 78 | 35 | 16.6 | 6 28309 21147 9 |
| MG | CM3589875M | 0.50 | 0.23 | | | | | | | 6 28309 21169 1 |
| ZN | CM3589875Z | 1.82 | 0.83 | in | 5.20 | 0.77 | 3.07 | 1.38 | 0.65 | 6 28309 21148 6 |

VOLVO PENTA DPR PLATE

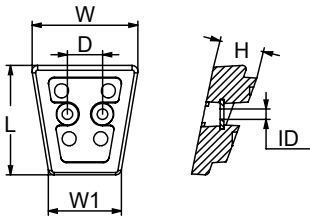
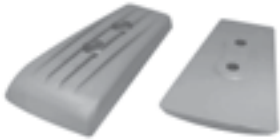

| | PID | LB | KG | | L | W | W1 | H | D | ID | UPC |
|----|------------|------|------|----|-----|-----|-----|-----|------|------|-----------------|
| AL | CM3841427A | 0.44 | 0.2 | mm | 94 | 93 | 61 | 38 | 30 | 9 | 6 28309 12636 0 |
| MG | CM3841427M | 0.29 | 0.13 | | | | | | | | 6 28309 15986 3 |
| ZN | CM3841427Z | 0.96 | 0.43 | in | 3.7 | 3.7 | 2.4 | 1.5 | 1.18 | 0.35 | 6 28309 12734 3 |

SX-A/APS-A

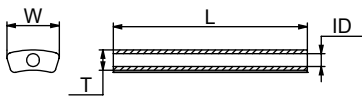

| | PID | LB | KG | | L | W | ID | T | UPC |
|----|------------|------|------|----|-----|-----|------|------|-----------------|
| AL | CM3852970A | 0.15 | 0.68 | mm | 104 | 28 | 7 | 11 | 6 28309 12577 6 |
| MG | CM3852970M | 0.1 | 0.05 | | | | | | 6 28309 19287 7 |
| ZN | CM3852970Z | 0.33 | 0.15 | in | 4 | 1.1 | 0.26 | 0.42 | 6 28309 19250 1 |

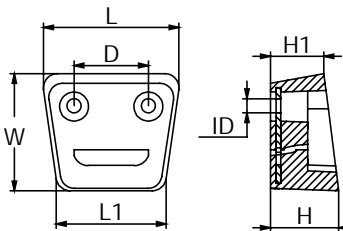

| | PID | LB | KG | | L | L1 | W | H | H1 | D | ID | UPC |
|----|------------|-----|------|----|------|------|------|------|------|----|------|-----------------|
| AL | CM3854130A | 0.9 | 0.41 | mm | 96 | 73 | 80 | 47 | 37 | 51 | 10 | 6 28309 12270 6 |
| MG | CM3854130M | 0.6 | 0.27 | | | | | | | | | 6 28309 12608 7 |
| ZN | CM3854130Z | 2.4 | 1.09 | in | 3.76 | 2.86 | 3.14 | 1.84 | 1.44 | 2 | 0.38 | 6 28309 11378 0 |

S. DRIVE - SX DRIVE



VOLVO PENTA™ anodes

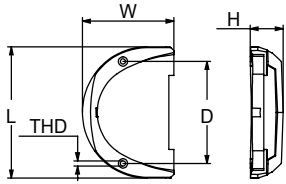

| | PID | LB | KG | | L | W | H | D | THD | UPC |
|----|------------|------|------|----|-----|-----|-----|-----|--------------|-----------------|
| AL | CM3855411A | 0.9 | 0.41 | mm | 145 | 103 | 37 | 113 | 1/4 - 20 UNC | 6 28309 12269 0 |
| MG | CM3855411M | 0.55 | 0.25 | | | | | | | 6 28309 12634 6 |
| ZN | CM3855411Z | 2.29 | 1.04 | in | 5.7 | 4 | 1.4 | 4.4 | | 6 28309 11372 8 |

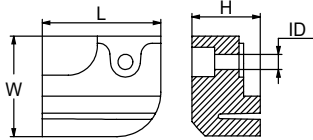

| | PID | LB | KG | | L | W | H | ID | UPC |
|----|------------|------|------|----|----|-----|-----|------|-----------------|
| AL | CM3861636A | 0.22 | 0.1 | mm | 52 | 43 | 30 | 6 | 6 28309 17074 5 |
| MG | CM3861636M | 0.14 | 0.06 | | | | | | 6 28309 17075 2 |
| ZN | CM3861636Z | 0.52 | 0.24 | in | 2 | 1.7 | 1.2 | 0.25 | 6 28309 17076 9 |

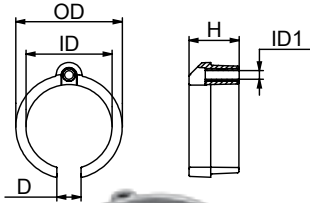

| | PID | LB | KG | | OD | ID | ID1 | D | H | UPC |
|----|------------|------|------|----|-----|------|------|------|-----|-----------------|
| AL | CM3861634A | 0.26 | 0.12 | mm | 78 | 64 | 6 | 18 | 37 | 6 28309 17071 4 |
| MG | CM3861634M | 0.15 | 0.07 | | | | | | | 6 28309 17072 1 |
| ZN | CM3861634Z | 0.66 | 0.30 | in | 3.1 | 2.52 | 0.25 | 0.71 | 1.5 | 6 28309 17073 8 |

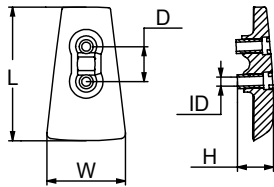

| | PID | LB | KG | | L | W | H | D | ID | UPC |
|----|------------|------|------|----|-----|-----|-----|-----|------|-----------------|
| AL | CM3863206A | 0.77 | 0.35 | mm | 132 | 78 | 36 | 35 | 9 | 6 28309 12722 0 |
| MG | CM3863206M | 0.61 | 0.28 | | | | | | | 6 28309 17606 8 |
| ZN | CM3863206Z | 1.57 | 0.71 | in | 5.2 | 3.1 | 1.4 | 1.4 | 0.35 | 6 28309 12692 6 |

DPH/DPR SERIES

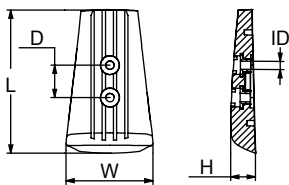

| | PID | LB | KG | | L | W | H | D | ID | UPC |
|----|------------|------|------|----|-----|-----|-----|-----|-----|-----------------|
| AL | CM3883728A | 1.1 | 0.5 | mm | 153 | 91 | 27 | 35 | 9 | 6 28309 12720 6 |
| MG | CM3883728M | 0.71 | 0.32 | | | | | | | 6 28309 15987 0 |
| ZN | CM3883728Z | 2.89 | 1.31 | in | 6 | 3.6 | 1.1 | 1.4 | 0.4 | 6 28309 12693 3 |

VOLVO PENTA™ anodes

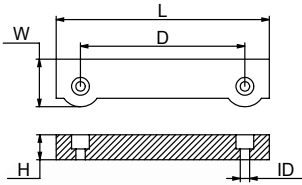

| | PID | LB | KG | | L | W | H | D | ID | UPC |
|----|-----------|------|------|----|-----|-----|-----|-----|-----|-----------------|
| AL | CM832598Z | 0.81 | 0.37 | mm | 188 | 41 | 22 | 145 | 8 | 6 28309 12265 2 |
| MG | CM832598A | 0.52 | 0.24 | | | | | | | 6 28309 10125 1 |
| ZN | CM832598M | 2.09 | 0.95 | in | 7.4 | 1.6 | 0.9 | 5.7 | 0.3 | 6 28309 10126 8 |

250-270-275-280-285 SERIES

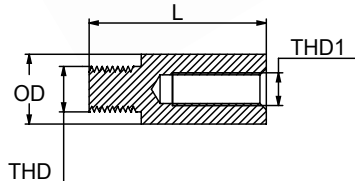

| | PID | LB | KG | | L | OD | THD | THD1 | UPC |
|----|-----------|------|-------|----|-----|------|------|------|-----------------|
| AL | CM838929Z | 0.04 | 0.18 | mm | 43 | 17 | 7/16 | M8 | 6 28309 12328 4 |
| MG | CM838929A | 0.02 | 0.009 | | | | - 14 | | 6 28309 19298 3 |
| ZN | CM838929M | 0.09 | 0.041 | in | 1.7 | 0.67 | UNC | | 6 28309 10128 2 |

200-250-270 SERIES

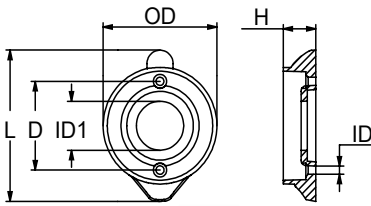

| | PID | LB | KG | | L | D | OD | ID | ID1 | H | UPC |
|----|-----------|------|------|----|-----|------|-----|------|------|-----|-----------------|
| AL | CM851983Z | 0.53 | 0.24 | mm | 124 | 73 | 96 | 7 | 40 | 27 | 6 28309 12326 0 |
| MG | CM851983A | 0.42 | 0.19 | | | | | | | | 6 28309 12190 7 |
| ZN | CM851983M | 1.08 | 0.49 | in | 4.9 | 2.85 | 3.8 | 0.26 | 1.57 | 1.1 | 6 28309 10134 3 |

S. DRIVE 120 SERIES

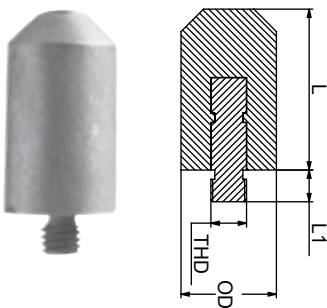

| | PID | LB | KG | | L | L1 | OD | THD | UPC |
|----|-----------|-------|-------|----|-----|-----|----|--------------|-----------------|
| AL | CM823661Z | 0.145 | 0.066 | mm | 43 | 10 | 26 | 3/8 - 16 UNC | 6 28309 10118 3 |
| MG | CM823661A | 0.106 | 0.048 | | | | | | 6 28309 12327 7 |
| ZN | CM823661M | 0.308 | 0.140 | in | 1.7 | 0.4 | 1 | | 6 28309 12374 1 |

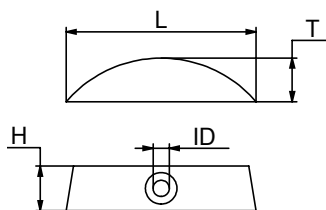

| | PID | LB | KG | | L | W | T | ID | UPC |
|----|-----------------------|------|------|----|-----|------|------|------|-----------------|
| AL | CM852018Z (CM850982Z) | 0.05 | 0.02 | mm | 64 | 15 | 15 | 5 | 6 28309 11522 7 |
| MG | CM852018A (CM850982A) | 0.03 | 0.01 | | | | | | 6 28309 12330 7 |
| ZN | CM852018M (CM850982M) | 0.12 | 0.05 | in | 2.5 | 0.59 | 0.57 | 0.21 | 6 28309 19299 0 |

110-120, S-B, S-C SERIES

VOLVO PENTA™ anodes

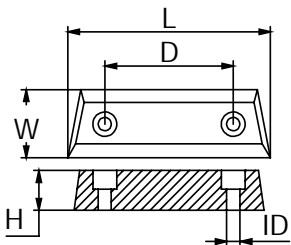

| | PID | LB | KG | | L | W | H | D | ID | UPC |
|----|-----------|------|------|----|------|------|----|-----|------|-----------------|
| AL | CM852835A | 0.66 | 0.3 | mm | 136 | 46 | 26 | 86 | 9 | 6 28309 12268 3 |
| MG | CM852835M | 0.42 | 0.19 | | | | | | | 6 28309 10135 0 |
| ZN | CM852835Z | 1.67 | 0.76 | in | 5.35 | 1.81 | 1 | 3.4 | 0.33 | 6 28309 10136 7 |

DUO PROP 290 SERIES

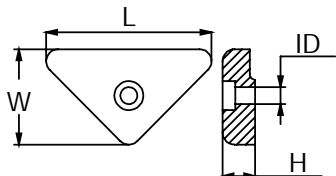

| | PID | LB | KG | | L | W | H | ID | UPC |
|----|-----------|------|------|----|-----|-----|-----|------|-----------------|
| AL | CM872793A | 0.11 | 0.05 | mm | 66 | 38 | 13 | 6 | 6 28309 12332 1 |
| MG | CM872793M | 0.07 | 0.03 | | | | | | 6 28309 17046 2 |
| ZN | CM872793Z | 0.24 | 0.11 | in | 2.6 | 1.5 | 0.5 | 0.25 | 6 28309 11367 4 |

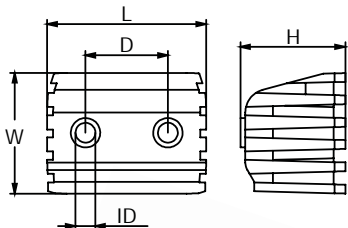

| | PID | LB | KG | | L | W | H | D | ID | UPC |
|----|-----------|------|------|----|-----|-----|-----|-----|------|-----------------|
| AL | CM873395A | 0.28 | 0.13 | mm | 54 | 41 | 36 | 28 | 7 | 6 28309 12637 7 |
| MG | CM873395M | 0.16 | 0.07 | | | | | | | 6 28309 15988 7 |
| ZN | CM873395Z | 0.61 | 0.28 | in | 2.1 | 1.6 | 1.4 | 1.1 | 0.26 | 6 28309 12736 7 |

DPX SERIES

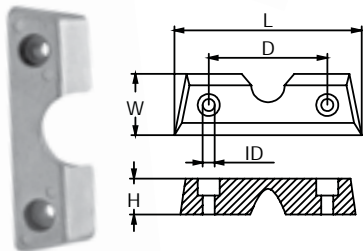

| | PID | LB | KG | | L | W | H | D | ID | UPC |
|----|-----------|------|------|----|------|-----|----|-----|------|-----------------|
| AL | CM872139A | 0.63 | 0.29 | mm | 136 | 46 | 26 | 86 | 9 | 6 28309 12331 4 |
| MG | CM872139M | 0.4 | 0.18 | | | | | | | 6 28309 19301 0 |
| ZN | CM872139Z | 1.43 | 0.65 | in | 5.35 | 1.8 | 1 | 3.4 | 0.33 | 6 28309 11366 7 |

DPX SERIES

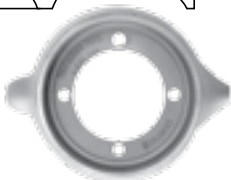
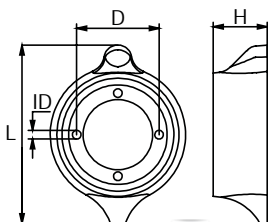

| | PID | LB | KG | | L | H | D | ID | UPC |
|----|-----------|------|------|----|-----|-----|------|------|-----------------|
| AL | CM875812A | 0.89 | 0.41 | mm | 140 | 43 | 65 | 6 | 6 28309 12333 8 |
| MG | CM875812M | 0.55 | 0.25 | | | | | | 6 28309 10141 1 |
| ZN | CM875812Z | 2.03 | 0.92 | in | 5.5 | 1.7 | 2.55 | 0.25 | 6 28309 10140 4 |

S. DRIVE 110 SERIES

VOLVO PENTA™ anodes

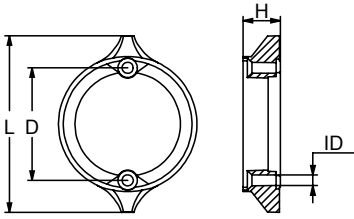

| | PID | LB | KG | | L | H | D | ID | UPC |
|----|-----------|------|------|----|-----|-----|------|------|-----------------|
| AL | CM875821A | 0.51 | 0.23 | mm | 145 | 29 | 92 | 9 | 6 28309 12267 6 |
| MG | CM875821M | 0.33 | 0.15 | | | | | | 6 28309 10141 1 |
| ZN | CM875821Z | 1.28 | 0.58 | in | 5.7 | 1.2 | 3.63 | 0.34 | 6 28309 10142 8 |

DUO PROP 290 SERIES

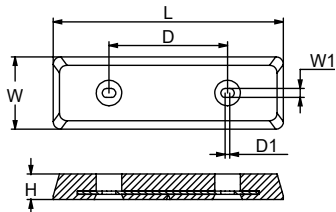

| | PID | LB | KG | | L | W | W1 | H | D | D1 | UPC |
|----|-------------|------|------|----|------|-----|-----|-----|------|------|-----------------|
| AL | CM40005875A | 3.33 | 1.51 | mm | 268 | 85 | 30 | 138 | 5 | 10 | 6 28309 17079 0 |
| MG | CM40005875M | 2.17 | 0.99 | | | | | | | | 6 28309 17077 6 |
| ZN | CM40005875Z | 7.95 | 3.61 | in | 10.5 | 3.3 | 1.2 | 5.4 | 0.21 | 0.41 | 6 28309 17078 3 |

IPS

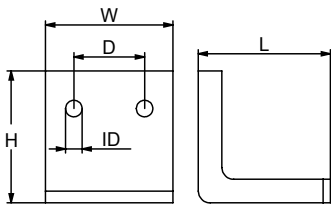

| | PID | LB | KG | | L | W | H | D | ID | UPC |
|----|-----------|------|------|----|-----|-----|-----|----|------|-----------------|
| AL | CM832934A | 0.55 | 0.25 | mm | 56 | 56 | 54 | 26 | 9 | 6 28309 23500 0 |
| MG | CM832934M | 0.35 | 0.16 | | | | | | | 6 28309 23501 7 |
| ZN | CM832934Z | 1.46 | 0.66 | in | 2.2 | 2.2 | 2.1 | 1 | 0.35 | 6 28309 23502 4 |

BRACKET TRIM 270

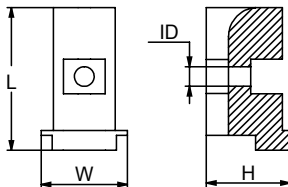

| | PID | LB | KG | | L | W | H | ID | UPC |
|----|-----------|------|------|----|-----|-----|-----|------|-----------------|
| AL | CM855105A | 0.04 | 0.02 | mm | 60 | 35 | 30 | 7 | 6 28309 20943 8 |
| MG | CM855105M | 0.02 | 0.01 | | | | | | 6 28309 20964 3 |
| ZN | CM855105Z | 0.35 | 0.16 | in | 2.4 | 1.4 | 1.2 | 0.28 | 6 28309 20985 8 |

S. DRIVE SERIES

VOLVO PENTA™ anodes

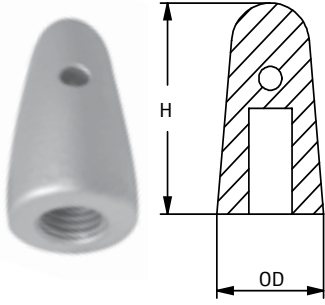

| | PID | LB | KG | | OD | H | THD | Shaft | UPC |
|----|-----------|------|------|----|------|------|------------|-------|-----------------|
| AL | CM833913A | 0.24 | 0.11 | mm | 37 | 70 | ¾ - 10 UNC | 22-25 | 6 28309 20961 2 |
| MG | CM833913M | 0.15 | 0.07 | | | | | | 6 28309 20982 7 |
| ZN | CM833913Z | 0.66 | 0.3 | in | 1.46 | 2.76 | | | 6 28309 20940 7 |
| AL | CM833915A | 0.24 | 0.11 | mm | 37 | 70 | ⅞ - 9 UNC | 30 | 6 28309 20962 9 |
| MG | CM833915M | 0.15 | 0.07 | | | | | | 6 28309 20983 4 |
| ZN | CM833915Z | 0.62 | 0.28 | in | 1.46 | 2.76 | | | 6 28309 20941 4 |
| AL | CM828140A | 0.42 | 0.19 | mm | 46 | 80 | 1 - 8 UNC | 40-45 | 6 28309 20960 5 |
| MG | CM828140M | 0.26 | 0.12 | | | | | | 6 28309 20981 0 |
| ZN | CM828140Z | 0.11 | 0.05 | in | 1.81 | 3.15 | | | 6 28309 20939 1 |

DPX SERIES

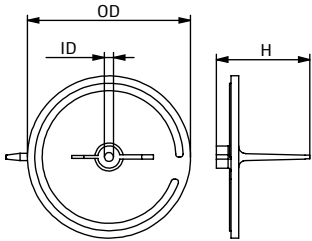

| | PID | LB | KG | | OD | ID | H | UPC |
|----|----------|------|------|----|-----|-----|-----|-----------------|
| ZN | CMVP339Z | 0.93 | 0.42 | mm | 110 | 13 | 63 | 6 28309 23818 6 |
| | | | | in | 4.3 | 0.5 | 2.5 | |

FB SERIES

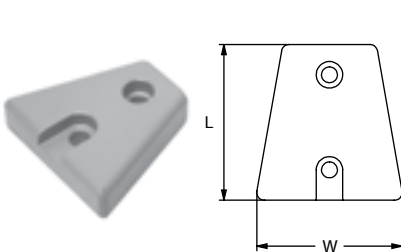

| | PID | LB | KG | | L | W | H | UPC |
|----|-----------|------|------|----|-----|-----|-----|-----------------|
| AL | CM876638A | | | mm | 59 | 55 | 14 | 6 28309 24181 0 |
| MG | CM876638M | | | | | | | 6 28309 24291 6 |
| ZN | CM876638Z | 0.47 | 0.22 | in | 2.3 | 2.2 | 0.5 | 6 28309 24114 8 |

DPX SERIES

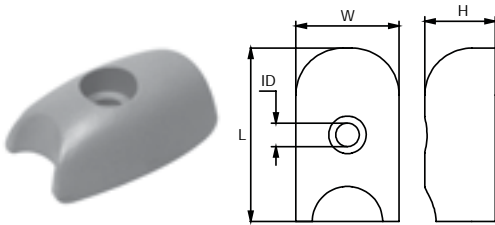

| | PID | LB | KG | | L | W | H | ID | UPC |
|----|------------|-----|------|----|-----|-----|-----|-----|-----------------|
| ZN | SGSP71180Z | 0.1 | 0.05 | mm | 37 | 22 | 15 | 7 | 6 28309 22311 3 |
| | | | | in | 1.5 | 0.9 | 0.6 | 0.3 | |

BOW THRUST

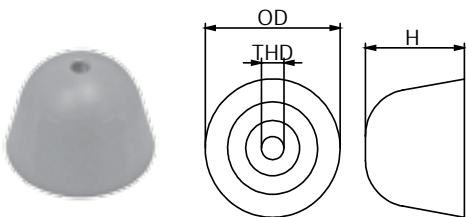

| | PID | LB | KG | | OD | H | THD | UPC |
|----|-------------|------|------|----|-----|-----|-----|-----------------|
| AL | CM41100098A | 0.04 | 0.02 | mm | 30 | 22 | M4 | 6 28309 20953 7 |
| MG | CM41100098M | 0.03 | 0.01 | | | | | 6 28309 20974 2 |
| ZN | CM41100098Z | 0.12 | 0.06 | in | 1.2 | 0.9 | | 6 28309 20932 2 |

OGIVE BOW THRUST

VOLVO PENTA™ anodes

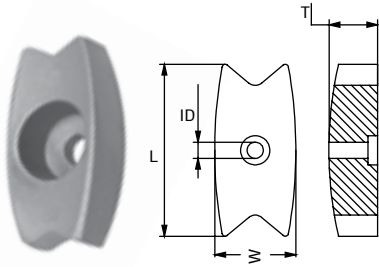

| | PID | LB | KG | | L | W | ID | T | UPC |
|----|-------------|------|------|----|----|----|------|------|-----------------|
| AL | CM41100276A | 0.06 | 0.03 | mm | 51 | 25 | 7 | 16 | 6 28309 23341 9 |
| MG | CM41100276M | 0.04 | 0.02 | | | | | | 6 28309 23342 6 |
| ZN | CM41100276Z | 0.19 | 0.08 | in | 2 | 1 | 0.26 | 0.62 | 6 28309 23343 3 |

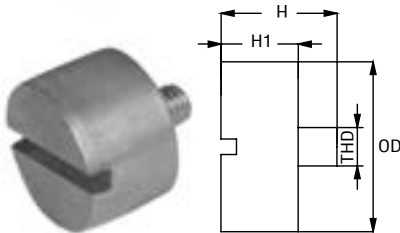

| | PID | LB | KG | | OD | H | H1 | THD | UPC |
|----|------------|------|------|----|-----|-----|-----|-----|-----------------|
| AL | CM8520219A | 0.04 | 0.02 | mm | 22 | 22 | 14 | M6 | 6 28309 20963 6 |
| MG | CM8520219M | 0.03 | 0.01 | | | | | | 6 28309 20984 1 |
| ZN | CM8520219Z | 0.08 | 0.04 | in | 0.9 | 0.9 | 0.5 | | 6 28309 20942 1 |

SEAL DRIVE 100

VOLVO PENTA™ anode kits



| | PID | LB | KG | Contains | Fits | UPC |
|----|-----------|------|------|---------------------------|---------------------|-----------------|
| AL | CM280KITA | 1.7 | 0.77 | CMV18 X 1 CM832598 X 1 | Volvo 280 Engine | 6 28309 12286 7 |
| MG | CM280KITM | 1.27 | 0.57 | | | 6 28309 12797 8 |
| ZN | CM280KITZ | 3.69 | 1.68 | | | 6 28309 12802 9 |



| | PID | LB | KG | Contains | Fits | UPC |
|----|-------------|------|------|------------------------------|----------------------------------|-----------------|
| AL | CM280DPKITA | 1.5 | 0.68 | CM875821 X 1 CM832598 X 1 | Volvo 280 Dual Prop Engine | 6 28309 12287 4 |
| MG | CM280DPKITM | 1.12 | 0.51 | | | 6 28309 12798 5 |
| ZN | CM280DPKITZ | 3.26 | 1.48 | | | 6 28309 12803 6 |



| | PID | LB | KG | Contains | Fits | UPC |
|----|-----------|------|------|--------------|---------------------|-----------------|
| AL | CM290KITA | 1.54 | 0.7 | CMV18 X 1 | Volvo 290 Engine | 6 28309 12288 1 |
| MG | CM290KITM | 1.23 | 0.56 | | | 6 28309 12799 2 |
| ZN | CM290KITZ | 3.59 | 1.63 | CM852835 X 1 | | 6 28309 12804 3 |

ALL KITS INCLUDE FASTENING HARDWARE, INSTALLATION INSTRUCTIONS, AND ALL OF THE ANODES REQUIRED FOR 100% PROTECTION.

VOLVO PENTA™ anode kits

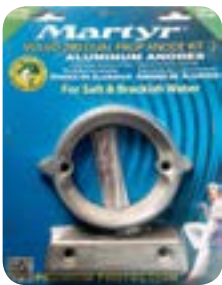

| PID | | LB | KG | Contains | Fits | UPC |
|-----|-------------|------|------|------------------------------|----------------------------------|-----------------|
| AL | CM290DPKITA | 1.44 | 0.65 | CM875821 X 1 CM852835 X 1 | Volvo 290 Dual Prop Engine | 6 28309 12289 8 |
| MG | CM290DPKITM | 1.15 | 0.52 | | | 6 28309 12800 5 |
| ZN | CM290DPKITZ | 3.35 | 1.52 | | | 6 28309 12805 0 |



| PID | | LB | KG | Contains | Fits | UPC |
|-----|-----------|------|------|--------------------------------|---------------------|-----------------|
| AL | CMDPHKITA | 1.22 | 0.55 | CM3588745 X 1 CM3863206 X 1 | Volvo DPH Engine | 6 28309 17047 9 |
| MG | CMDPHKITM | 0.91 | 0.41 | | | 6 28309 17048 6 |
| ZN | CMDPHKITZ | 2.65 | 1.2 | | | 6 28309 17049 3 |



| PID | | LB | KG | Contains | Fits | UPC |
|-----|----------|------|------|--------------------------------|-----------------|-----------------|
| AL | CMSXKITA | 2.27 | 1.03 | CM3855411 X 1 CM3854130 X 1 | Volvo SX Engine | 6 28309 12290 4 |
| MG | CMSXKITM | 1.69 | 0.77 | | | 6 28309 12801 2 |
| ZN | CMSXKITZ | 4.93 | 2.24 | | | 6 28309 12806 7 |



| PID | | LB | KG | Contains | Fits | UPC |
|-----|-----------|------|------|--------------------------------|--------------------------|-----------------|
| AL | CMSXAKITA | 1.54 | 0.65 | CM3841427 X 1 CM3883728 X 1 | Volvo SX-A/DPS Engine | 6 28309 17050 9 |
| MG | CMSXAKITM | 1.18 | 0.54 | | | 6 28309 17051 6 |
| ZN | CMSXAKITZ | 3.35 | 1.52 | | | 6 28309 17052 3 |



| PID | | LB | KG | Contains | Fits | UPC |
|-----|---------------|------|------|---------------|--|-----------------|
| AL | CM3858399KITA | 0.16 | 0.07 | CM3858286 X 3 | Volvo Folding Prop 3-blade Engine D2-55A, B, C, D, E, F | 6 28309 15934 4 |
| MG | CM3858399KITM | 0.1 | 0.04 | | | 6 28309 15935 1 |
| ZN | CM3858399KITZ | 0.4 | 0.18 | | | 6 28309 15933 7 |

ALL KITS INCLUDE FASTENING HARDWARE, INSTALLATION INSTRUCTIONS, AND ALL OF THE ANODES REQUIRED FOR 100% PROTECTION.

VOLVO™ anode kits



| | PID | LB | KG | Contains | Fits | UPC |
|----|-------------|------|------|---|-------------------------|-----------------|
| AL | CM290EUKITA | 1.85 | 0.84 | CMV18 X 1 CM852835 X 1 CM872793 X 2 | Fits Volvo Penta 290 | 6 28309 25508 4 |
| MG | CM290EUKITM | 1.32 | 0.60 | | | 6 28309 25509 1 |
| ZN | CM290EUKITZ | 3.74 | 1.70 | | | 6 28309 25510 7 |



| | PID | LB | KG | Contains | Fits | UPC |
|----|---------------|------|------|--|---------------------------|-----------------|
| AL | CM290DPEUKITA | 1.67 | 0.76 | CM875821 X 1 CM852835 X 1 CM872793 X 1 | Fits Volvo Penta 290DP | 6 28309 25505 3 |
| MG | CM290DPEUKITM | 1.23 | 0.56 | | | 6 28309 25506 0 |
| ZN | CM290DPEUKITZ | 2.2 | 0.54 | | | 6 28309 25507 7 |



| | PID | LB | KG | Contains | Fits | UPC |
|----|---------------|------|------|----------------|-------------------------------|-----------------|
| AL | CM3584442KITA | 0.46 | 0.21 | CM3584442D X 3 | Volvo 4-Blade Folding Prop | 6 28309 25511 4 |
| MG | CM3584442KITM | 0.40 | 0.18 | | | 6 28309 25512 1 |
| ZN | CM3584442KITZ | 0.70 | 0.32 | | | 6 28309 25513 8 |

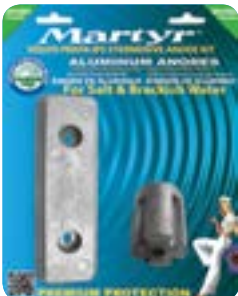

| | PID | LB | KG | Contains | Fits | UPC |
|----|-------------|------|------|---------------------------------|------------------------------|-----------------|
| AL | CMVPIPSKITA | 4.18 | 1.90 | CM3593881 X 1 CM40005875 X 1 | VolvoPenta IPS SternDrive | 6 28309 26012 5 |
| MG | CMVPIPSKITM | 2.77 | 1.26 | | | 6 28309 26034 7 |
| ZN | CMVPIPSKITZ | 9.86 | 4.48 | | | 6 28309 25988 4 |

ALL KITS INCLUDE FASTENING HARDWARE, INSTALLATION INSTRUCTIONS, AND ALL OF THE ANODES REQUIRED FOR 100% PROTECTION.

YAMAHA™ anodes

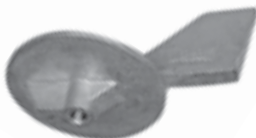
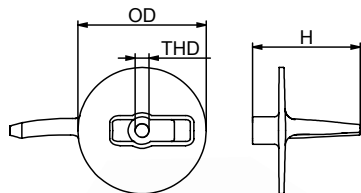
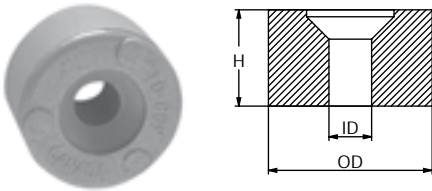
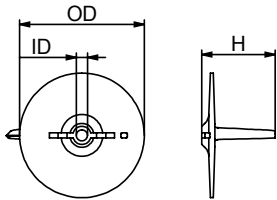
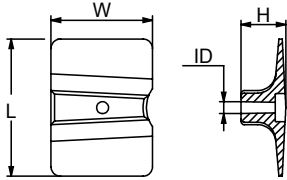
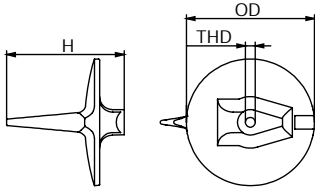

| | PID | LB | KG | | OD | H | THD | UPC |
|----|---------------|------|------|----|-----|-----|----------|-----------------|
| AL | CM61A4537100A | 0.55 | 0.25 | mm | 99 | 91 | M10x1.25 | 6 28309 12641 4 |
| MG | CM61A4537100M | 0.34 | 0.16 | | | | | 6 28309 12642 1 |
| ZN | CM61A4537100Z | 1.38 | 0.63 | in | 3.6 | 3.9 | | 6 28309 11521 0 |

| | PID | LB | KG | | L | H | D | ID | UPC |
|----|---------------|------|------|----|-----|-----|----|------|-----------------|
| AL | CM61N4525101A | 0.23 | 0.1 | mm | 80 | 59 | 26 | 6 | 6 28309 12666 7 |
| MG | CM61N4525101M | 0.16 | 0.07 | | | | | | 6 28309 12667 4 |
| ZN | CM61N4525101Z | 0.58 | 0.26 | in | 3.1 | 2.3 | 1 | 0.24 | 6 28309 11518 0 |

YAMAHA 8 - 9,9 - 13 - 25 - 60 HP
 Also apply to Parsun, ALLPASS, Hidea, Tiger, Painier & ShenFeng

| | PID | LB | KG | | OD | H | ID | UPC |
|----|---------------|------|------|----|-----|-----|------|-----------------|
| AL | CM6644537101A | 0.25 | 0.11 | mm | 96 | 57 | 9 | 6 28309 12643 8 |
| MG | CM6644537101M | 0.15 | 0.07 | | | | | 6 28309 10064 3 |
| ZN | CM6644537101Z | 0.62 | 0.28 | in | 3.8 | 2.2 | 0.33 | 6 28309 10065 0 |

Also apply to Parsun, ALLPASS, Hidea, Tiger, Painier & ShenFeng

| | PID | LB | KG | | OD | ID | H | UPC |
|----|---------------|------|------|----|-----|------|------|-----------------|
| AL | CM6884525101A | 0.03 | 0.01 | mm | 24 | 6 | 14 | 6 28309 12644 5 |
| MG | CM6884525101M | 0.02 | 0.01 | | | | | 6 28309 12645 2 |
| ZN | CM6884525101Z | 0.06 | 0.03 | in | 0.9 | 0.25 | 0.55 | 6 28309 10066 7 |

2 - 115 HP / MARINER 40 HP / YAMAHA 70 - 85 HP

| | PID | LB | KG | | OD | H | THD | UPC |
|----|---------------|------|------|----|-----|----|----------|-----------------|
| AL | CM6884537102A | 0.42 | 0.19 | mm | 92 | 77 | M10x1.25 | 6 28309 12646 9 |
| MG | CM6884537102M | 0.25 | 0.11 | | | | | 6 28309 10067 4 |
| ZN | CM6884537102Z | 1.05 | 0.48 | in | 3.6 | 3 | | 6 28309 10068 1 |

YAMAHA 50 - 60 - 70 - 75 - 80 - 85 - 90 HP
 Also apply to Parsun & Painier

YAMAHA™ anodes

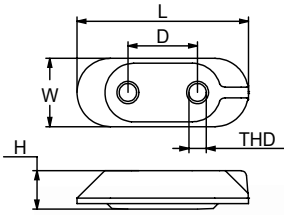

| | PID | LB | KG | | L | W | H | D | THD | UPC |
|----|---------------|------|------|----|-----|----|-----|----|-----|-----------------|
| AL | CM6E04525111A | 0.09 | 0.04 | mm | 64 | 25 | 14 | 26 | M6 | 6 28309 12647 6 |
| MG | CM6E04525111M | 0.08 | 0.04 | | | | | | | 6 28309 12648 3 |
| ZN | CM6E04525111Z | 0.22 | 0.1 | in | 2.5 | 1 | 0.5 | 1 | | 6 28309 10069 8 |

YAMAHA 40 HP / YAMAHA 4 - 6 - 8 - 9,9 - 15 HP UP TO 1989
Also apply to ALLPASS & Painier

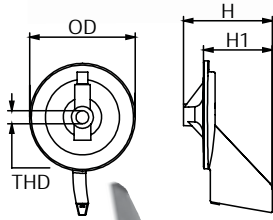

| | PID | LB | KG | | OD | H | H1 | THD | UPC |
|----|---------------|------|------|----|-----|-----|-----|----------|-----------------|
| AL | CM6J94537101A | 0.44 | 0.2 | mm | 100 | 84 | 65 | M10x1.25 | 6 28309 12659 9 |
| MG | CM6J94537101M | 0.28 | 0.13 | | | | | | 6 28309 12369 7 |
| ZN | CM6J94537101Z | 1.1 | 0.5 | in | 3.9 | 3.3 | 2.6 | | 6 28309 12351 2 |

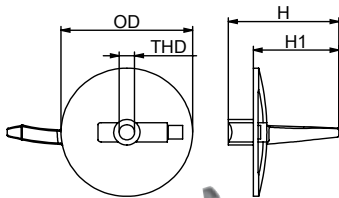

| | PID | LB | KG | | OD | H | H1 | THD | UPC |
|----|---------------|------|------|----|-----|-----|-----|----------|-----------------|
| AL | CM6K14537102A | 0.44 | 0.2 | mm | 100 | 84 | 65 | M10x1.25 | 6 28309 12660 5 |
| MG | CM6K14537102M | 0.28 | 0.13 | | | | | | 6 28309 12661 2 |
| ZN | CM6K14537102Z | 1.1 | 0.5 | in | 3.9 | 3.3 | 2.6 | | 6 28309 12352 9 |

Counter Rotation to CM6J94537101

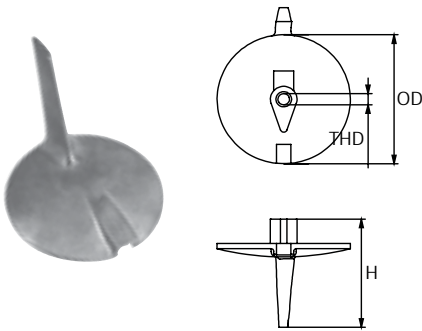

| | PID | LB | KG | | OD | H | THD | UPC |
|----|---------------|------|------|----|-----|-----|----------|-----------------|
| AL | CM69L4537100A | 0.46 | 0.21 | mm | 99 | 91 | M10x1.25 | 6 28309 12318 5 |
| MG | CM69L4537100M | 0.32 | 0.14 | | | | | 6 28309 12669 8 |
| ZN | CM69L4537100Z | 1.15 | 0.52 | in | 3.9 | 3.6 | | 6 28309 12317 8 |

YAMAHA 200 - 225 - 250 - 300 HP

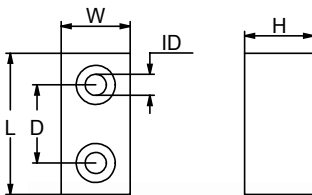

| | PID | LB | KG | | L | W | H | D | ID | UPC |
|----|---------------|------|------|----|-----|-----|-----|-----|------|-----------------|
| AL | CM6E54525100A | 0.12 | 0.05 | mm | 47 | 23 | 23 | 23 | 7 | 6 28309 12649 0 |
| MG | CM6E54525100M | 0.08 | 0.04 | | | | | | | 6 28309 12650 6 |
| ZN | CM6E54525100Z | 0.3 | 0.14 | in | 1.8 | 0.9 | 0.9 | 0.9 | 0.26 | 6 28309 10071 1 |

YAMAHA™ anodes

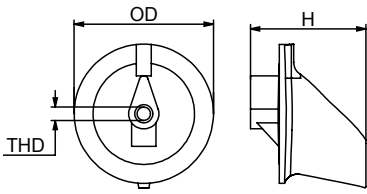

| | PID | LB | KG | | OD | H | THD | UPC |
|----|---------------|------|------|----|-----|----|----------|-----------------|
| AL | CM6E54537101A | 0.37 | 0.17 | mm | 92 | 76 | M10x1.25 | 6 28309 12651 3 |
| MG | CM6E54537101M | 0.23 | 0.11 | | | | | 6 28309 12652 0 |
| ZN | CM6E54537101Z | 0.92 | 0.42 | in | 3.6 | 3 | | 6 28309 10072 8 |

YAMAHA 150 - 200 HP

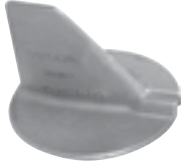
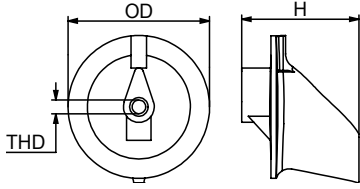

| | PID | LB | KG | | OD | H | THD | UPC |
|----|---------------|------|------|----|-----|----|----------|-----------------|
| AL | CM6K14537100A | 0.37 | 0.17 | mm | 92 | 76 | M10x1.25 | 6 28309 12653 7 |
| MG | CM6K14537100M | 0.23 | 0.11 | | | | | 6 28309 12654 4 |
| ZN | CM6K14537100Z | 0.92 | 0.42 | in | 3.6 | 3 | | 6 28309 10079 7 |

Counter Rotation to CM6E54537101

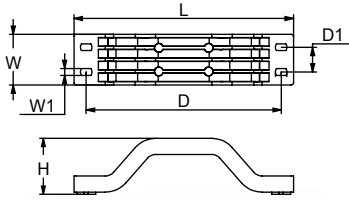

| | PID | LB | KG | | L | W | W1 | H | D | D1 | UPC |
|----|---------------|-----|------|----|-----|-----|------|----|-----|------|-----------------|
| AL | CM6G54525101A | 0.8 | 0.37 | mm | 203 | 47 | 6 | 52 | 180 | 23 | 6 28309 12655 1 |
| MG | CM6G54525101M | 0.5 | 0.23 | | | | | | | | 6 28309 12656 8 |
| ZN | CM6G54525101Z | 2 | 0.91 | in | 8 | 1.8 | 0.24 | 2 | 7.1 | 0.91 | 6 28309 10075 9 |

V6 UP TO 1989 / YAMAHA 115 - 130 - 150 - 175 -200 - 225 -250 HP

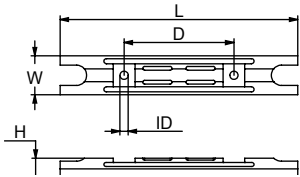

| | PID | LB | KG | | L | W | H | D | ID | UPC |
|----|---------------|------|------|----|-----|-----|-----|-----|------|-----------------|
| AL | CM6H14525102A | 0.43 | 0.2 | mm | 203 | 36 | 17 | 101 | 7 | 6 28309 12657 5 |
| MG | CM6H14525102M | 0.27 | 0.12 | | | | | | | 6 28309 12658 2 |
| ZN | CM6H14525102Z | 1.08 | 0.49 | in | 8 | 1.4 | 0.7 | 4 | 0.28 | 6 28309 10076 6 |

YAMAHA 60 - 70 - 75 - 80 - 90 -100 HP
Also apply to Parsun & ALLPASS

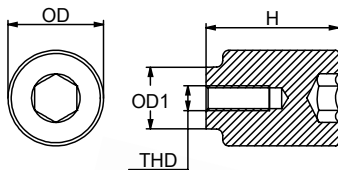

| | PID | LB | KG | | OD | OD1 | H | THD | UPC |
|----|---------------|------|------|----|-----|-----|-----|-----|-----------------|
| AL | CM68V1132501A | 0.06 | 0.03 | mm | 23 | 15 | 33 | M6 | 6 28309 12256 0 |
| MG | CM68V1132501M | 0.04 | 0.02 | | | | | | 6 28309 21031 1 |
| ZN | CM68V1132501Z | 0.15 | 0.07 | in | 0.9 | 0.6 | 1.3 | | 6 28309 18126 0 |

YAMAHA™ anodes

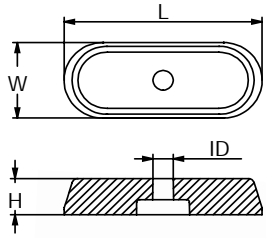

| | PID | LB | KG | | L | W | H | ID | UPC |
|----|---------------|------|------|----|-----|----|-----|-----|-----------------|
| AL | CM68T4525100A | 0.09 | 0.04 | mm | 64 | 25 | 12 | 7 | 6 28309 19297 6 |
| MG | CM68T4525100M | 0.06 | 0.03 | | | | | | 6 28309 18439 1 |
| ZN | CM68T4525100Z | 0.22 | 0.1 | in | 2.5 | 1 | 0.5 | 0.3 | 6 28309 17662 4 |

YAMAHA F6 - F8 - F9,9

Also apply to Hidea & Tiger

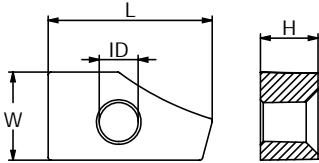

| | PID | LB | KG | | L | W | H | ID | UPC |
|----|---------------|------|------|----|-----|------|------|------|-----------------|
| AL | CM6891132500A | 0.02 | 0.01 | mm | 28 | 15 | 10 | 6 | 6 28309 23161 3 |
| MG | CM6891132500M | 0.01 | 0.01 | | | | | | 6 28309 23175 0 |
| ZN | CM6891132500Z | 0.05 | 0.02 | in | 1.1 | 0.59 | 0.39 | 0.24 | 6 28309 23149 1 |

Also apply to Parsun

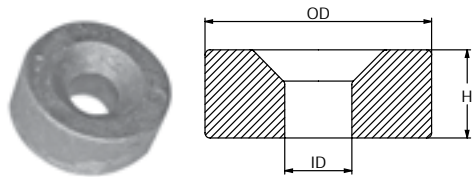

| | PID | LB | KG | | OD | H | ID | UPC |
|----|---------------|--------|--------|----|------|------|------|-----------------|
| AL | CM41106ZW000A | 0.0149 | 0.0067 | mm | 22 | 6.5 | 8.5 | 6 28309 23347 1 |
| MG | CM41106ZW000M | 0.0095 | 0.0043 | | | | | 6 28309 23348 8 |
| ZN | CM41106ZW000Z | 0.0386 | 0.0175 | in | 0.86 | 0.25 | 0.33 | 6 28309 23349 5 |

2 - 115 HP / MARINER 2 - 25 HP / YAMAHA 2 - 25 HP

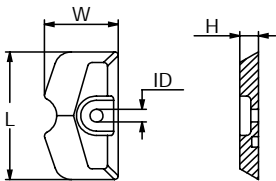

| | PID | LB | KG | | L | W | H | ID | UPC |
|----|---------------|-------|-------|----|-----|-----|-----|-----|-----------------|
| AL | CM6L54525102A | 0.059 | 0.027 | mm | 60 | 34 | 9 | 6 | 6 28309 18520 6 |
| MG | CM6L54525102M | 0.037 | 0.017 | | | | | | 6 28309 18521 3 |
| ZN | CM6L54525102Z | 0.154 | 0.070 | in | 2.4 | 1.3 | 0.3 | 0.2 | 6 28309 18513 8 |

Also apply to Parsun

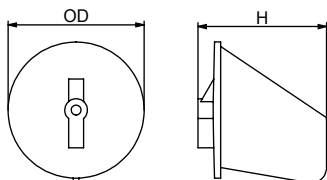

| | PID | LB | KG | | OD | H | UPC |
|----|---------------|------|------|----|-----|-----|-----------------|
| AL | CM6794525100A | 0.49 | 0.22 | mm | 90 | 85 | 6 28309 23404 1 |
| MG | CM6794525100M | 0.30 | 0.13 | | | | 6 28309 23405 8 |
| ZN | CM6794525100Z | 1.23 | 0.56 | in | 3.5 | 3.3 | 6 28309 23406 5 |

MARINER 40 - 60 HP 10 X 1,25 / MARINER 40 - 60 HP 7/16" /
YAMAHA 55 HP 10 X 1,25

YAMAHA™ anodes

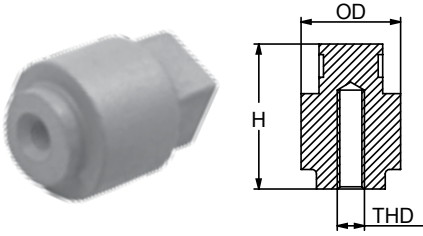

| PID | | LB | KG | | OD | H | THD | UPC |
|-----|---------------|-------|-------|----|-----|-----|-----|-----------------|
| ZN | CM67F1132500Z | 0.121 | 0.055 | mm | 22 | 32 | M6 | 6 28309 23409 6 |
| | | | | in | 0.9 | 1.3 | | |

80-100 HP

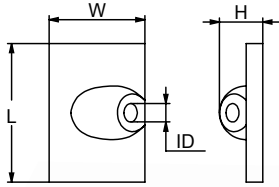

| PID | | LB | KG | | L | W | H | ID | UPC |
|-----|----------|------|------|----|------|-----|------|------|-----------------|
| ZN | CM42121Z | 0.07 | 0.03 | mm | 42 | 29 | 11 | 7 | 6 28309 20933 9 |
| | | | | in | 1.66 | 1.1 | 0.42 | 0.28 | |

6-9.9 HP MARINER

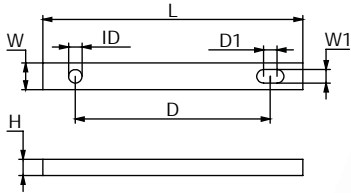
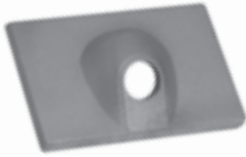

| PID | | LB | KG | | L | W | W1 | H | D | D1 | ID | UPC |
|-----|-----------|------|------|----|-----|------|------|-----|------|------|------|-----------------|
| ZN | CM825271Z | 0.64 | 0.29 | mm | 193 | 19 | 6 | 12 | 167 | 8 | 6 | 6 28309 20937 7 |
| | | | | in | 7.6 | 0.75 | 0.25 | 0.5 | 6.58 | 0.32 | 0.25 | |

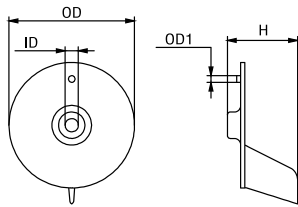

| PID | | LB | KG | | OD | OD1 | ID | H | UPC |
|-----|-----------|------|------|----|-----|------|------|-----|-----------------|
| AL | CM82795MA | 0.15 | 0.07 | mm | 95 | 5 | 9 | 53 | 6 28309 20959 9 |
| MG | CM82795MM | 0.11 | 0.05 | | | | | | 6 28309 20980 3 |
| ZN | CM82795MZ | 0.42 | 0.19 | in | 3.7 | 0.19 | 0.33 | 2.1 | 6 28309 20938 4 |

25-30 HP YAMAHA

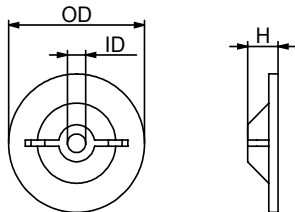

| PID | | LB | KG | | OD | ID | H | UPC |
|-----|---------------|------|------|----|-----|------|-----|-----------------|
| AL | CM6E84525100A | 0.04 | 0.02 | mm | 45 | 6 | 10 | 6 28309 23882 7 |
| MG | CM6E84525100M | 0.02 | 0.01 | | | | | 6 28309 23886 5 |
| ZN | CM6E84525100Z | 0.14 | 0.06 | in | 1.8 | 0.25 | 0.4 | 6 28309 23877 3 |

9.9 HP



YAMAHA™ anodes

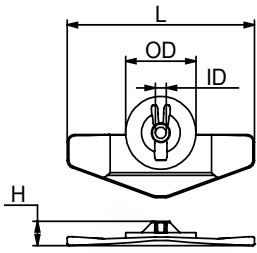

| | PID | LB | KG | | L | H | ID | OD | UPC |
|----|---------------|------|------|----|-----|------|------|-----|-----------------|
| AL | CM6E84525102A | 0.13 | 0.06 | mm | 120 | 15 | 7 | 45 | 6 28309 23419 5 |
| MG | CM6E84525102M | 0.09 | 0.04 | | | | | | 6 28309 23420 1 |
| ZN | CM6E84525102Z | 0.32 | 0.15 | in | 4.7 | 0.59 | 0.27 | 1.8 | 6 28309 23421 8 |

9.9-15 HP

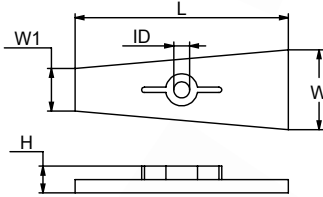

| | PID | LB | KG | | L | W | W1 | H | ID | UPC |
|----|---------------|-------|-------|----|-----|-----|-----|------|------|-----------------|
| AL | CM6G14525102A | 0.024 | 0.011 | mm | 80 | 30 | 14 | 6 | 7 | 6 28309 23422 5 |
| MG | CM6G14525102M | 0.015 | 0.007 | | | | | | | 6 28309 23423 2 |
| ZN | CM6G14525102Z | 0.07 | 0.03 | in | 3.1 | 1.2 | 0.5 | 0.24 | 0.27 | 6 28309 23424 9 |

6-8 HP UP TO 1989

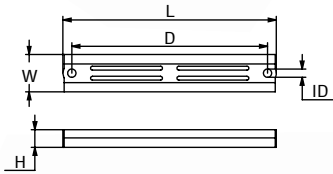

| | PID | LB | KG | | L | W | H | D | ID | UPC |
|----|---------------|------|------|----|-----|------|------|-----|------|-----------------|
| AL | CM6H14525101A | 0.51 | 0.23 | mm | 205 | 36 | 17 | 188 | 8 | 6 28309 21159 2 |
| MG | CM6H14525101M | 0.33 | 0.15 | | | | | | | 6 28309 21180 6 |
| ZN | CM6H14525101Z | 1.23 | 0.56 | in | 8 | 1.42 | 0.67 | 7.4 | 0.31 | 6 28309 21135 6 |

YAMAHA 40 - 50 - 55 - 70 - 85 - 90 HP

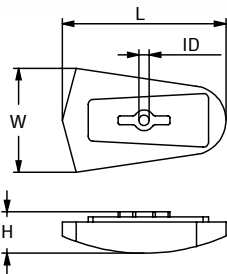

| | PID | LB | KG | | L | W | H | ID | UPC |
|----|---------------|------|------|----|-----|-----|-----|------|-----------------|
| ZN | CM6G14525103Z | 0.37 | 0.17 | mm | 95 | 60 | 13 | 6 | 6 28309 23427 0 |
| | | | | in | 3.7 | 2.4 | 0.5 | 0.25 | |

YAMAHA 6 HP UP TO 2000 - 8 HP

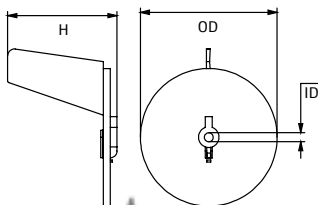

| | PID | LB | KG | | OD | ID | H | UPC |
|----|---------------|------|------|----|-----|------|------|-----------------|
| ZN | CM6T54537100Z | 1.15 | 0.52 | mm | 100 | 11 | 88 | 6 28309 23463 8 |
| | | | | in | 3.9 | 0.43 | 3.46 | |

130-160 HP



YAMAHA™ anodes

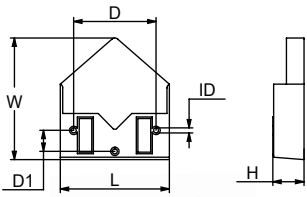

| | PID | LB | KG | | L | W | H | D | D1 | ID | UPC |
|----|---------------|------|------|----|-----|-----|------|------|------|------|-----------------|
| ZN | CM6T44583600Z | 3.17 | 1.44 | mm | 150 | 130 | 39 | 118 | 25 | 9 | 6 28309 23460 7 |
| | | | | in | 5.9 | 5.1 | 1.54 | 4.65 | 0.98 | 0.35 | |

V8

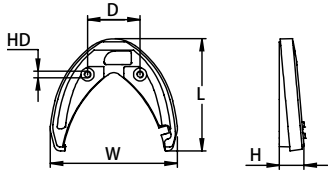

| | PID | LB | KG | | L | W | H | D | THD | UPC |
|----|---------------|------|------|----|------|------|------|------|---------|-----------------|
| AL | CM6T54537300A | 0.84 | 0.38 | mm | 138 | 155 | 33 | 64 | M8x1.25 | 6 28309 23464 5 |
| MG | CM6T54537300M | 0.53 | 0.24 | | | | | | | 6 28309 23465 2 |
| ZN | CM6T54537300Z | 2.18 | 0.99 | in | 5.43 | 6.10 | 1.30 | 2.52 | | 6 28309 23466 9 |

130-260 HP
YAMAHA STERN DRIVE 1989

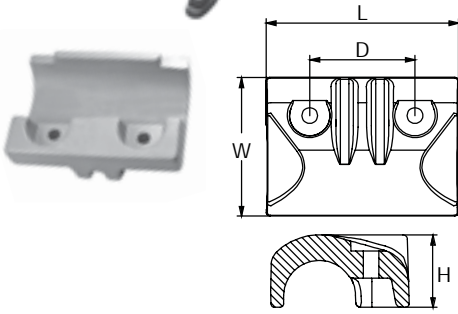

| | PID | LB | KG | | L | W | H | D | UPC |
|----|---------------|------|------|----|-----|-----|-----|------|-----------------|
| ZN | CM63D4525101Z | 1.19 | 0.54 | mm | 85 | 62 | 32 | 47 | 6 28309 23244 3 |
| | | | | in | 3.3 | 2.4 | 1.3 | 1.85 | |

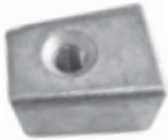
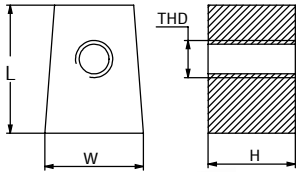

| | PID | LB | KG | | L | W | H | THD | UPC |
|----|---------------|------|------|----|------|----|------|---------|-----------------|
| AL | CM67C4525100A | 0.12 | 0.05 | mm | 35 | 25 | 24 | M8x1.25 | 6 28309 20957 5 |
| MG | CM67C4525100M | 0.07 | 0.03 | | | | | | 6 28309 20978 0 |
| ZN | CM67C4525100Z | 0.26 | 0.12 | in | 1.36 | 1 | 0.93 | | 6 28309 20936 0 |

OUTBOARD

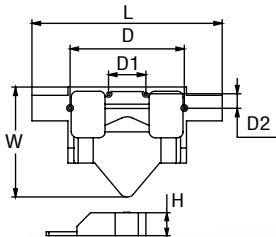

| | PID | LB | KG | | L | W | H | D | D1 | D2 | ID | UPC |
|----|---------------|------|------|----|-----|-----|------|------|------|------|----|-----------------|
| AL | CM6U04525100A | 1.31 | 0.59 | mm | 230 | 130 | 30 | 146 | 35 | 27 | 7 | 6 28309 23216 0 |
| MG | CM6U04525100M | 0.83 | 0.38 | | | | | | | | | 6 28309 23230 6 |
| ZN | CM6U04525100Z | 3.3 | 1.5 | in | 9 | 5.1 | 1.18 | 5.75 | 1.37 | 1.06 | | 0.26 |

YAMAHA TD IN OUTBOARDS

YAMAHA™ anodes

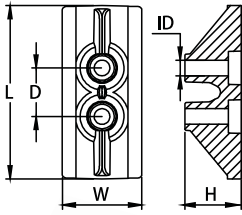

| | PID | LB | KG | | L | W | H | D | ID | UPC |
|----|---------------|------|------|----|------|------|------|------|------|-----------------|
| AL | CM6U34525101A | 0.24 | 0.11 | mm | 100 | 45.7 | 32.5 | 28 | 9 | 6 28309 23467 6 |
| MG | CM6U34525101M | 0.15 | 0.07 | | | | | | | 6 28309 23468 3 |
| ZN | CM6U34525101Z | 0.62 | 0.28 | in | 3.94 | 1.80 | 1.28 | 1.10 | 0.35 | 6 28309 23469 0 |

YAMAHA TD IN OUTBOARDS

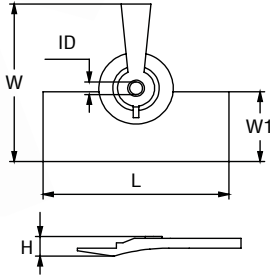

| | PID | LB | KG | | L | W | W1 | H | ID | UPC |
|----|---------------|------|------|----|-----|------|------|------|------|-----------------|
| AL | CM6G84525101A | 0.17 | 0.08 | mm | 100 | 9 | 37 | 20 | 7 | 6 28309 23428 7 |
| MG | CM6G84525101M | 0.11 | 0.05 | | | | | | | 6 28309 23429 4 |
| ZN | CM6G84525101Z | 0.44 | 0.2 | in | 3.9 | 0.35 | 1.46 | 0.79 | 0.27 | 6 28309 23430 0 |

9.9 HP

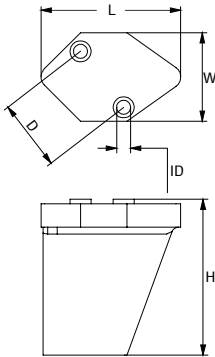

| | PID | LB | KG | | L | W | H | D | ID | UPC |
|----|---------------|------|------|----|-----|-----|-----|------|------|-----------------|
| ZN | CM66M4537100Z | 0.18 | 0.08 | mm | 53 | 38 | 65 | 31 | 7 | 6 28309 23403 4 |
| | | | | in | 2.1 | 1.5 | 2.6 | 1.22 | 0.28 | |

YAMAHA 9,9 - 15 HP

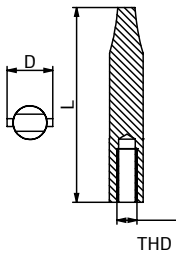

| | PID | LB | KG | | L | D | THD | UPC |
|----|---------------|------|------|----|----|------|-----|-----------------|
| ZN | CM62Y1132500Z | 0.04 | 0.02 | mm | 50 | 11 | M5 | 6 28309 21133 2 |
| | | | | in | 2 | 0.43 | | |

Also apply to Parsun

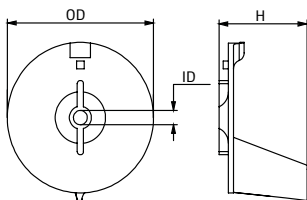

| | PID | LB | KG | | OD | ID | H | UPC |
|----|---------------|------|------|----|-----|------|-----|-----------------|
| AL | CM67C4537100A | 0.2 | 0.09 | mm | 95 | 9 | 57 | 6 28309 21158 5 |
| MG | CM67C4537100M | 0.11 | 0.05 | | | | | 6 28309 21179 0 |
| ZN | CM67C4537100Z | 0.46 | 0.21 | in | 3.7 | 0.35 | 2.2 | 6 28309 21134 9 |

F25 - F30 - F40 - F50 - F60



YAMAHA™ anodes

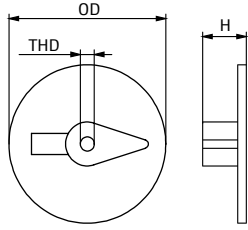

| | PID | LB | KG | | OD | H | THD | UPC |
|----|---------------|------|------|----|-----|------|----------|-----------------|
| ZN | CM6E54537110Z | 0.51 | 0.23 | mm | 90 | 22 | M10x1.25 | 6 28309 23415 7 |
| | | | | in | 3.5 | 0.87 | | |

YAMAHA 60 -70 -80 -90 - 115 -130 -150 -175 -200 -225 - HP

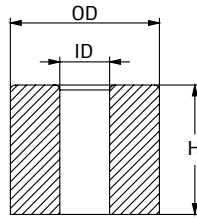

| | PID | LB | KG | | OD | ID | H | UPC |
|----|---------------|------|------|----|------|------|------|-----------------|
| ZN | CM6G81132500Z | 0.03 | 0.01 | mm | 14 | 5 | 16 | 6 28309 23151 4 |
| | | | | in | 0.54 | 0.21 | 0.63 | |

4 - 6 -8 -9 - 9,9 -15 -20 -25 - 30 - 40 - 50 - 60 - 70 HP

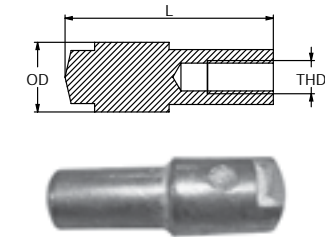

| | PID | LB | KG | | L | OD | THD | UPC |
|----|---------------|------|------|----|-----|-----|-----|-----------------|
| AL | CM66M1132500A | 0.01 | 0.01 | mm | 32 | 11 | 5 | 6 28309 23156 9 |
| MG | CM66M1132500M | 0.01 | 0.01 | | | | | 6 28309 23170 5 |
| ZN | CM66M1132500Z | 0.03 | 0.01 | in | 1.3 | 0.4 | 0.2 | 6 28309 23144 6 |

YAMAHA 9,9 - 15 - 200 - 225 -250 - 300 HP

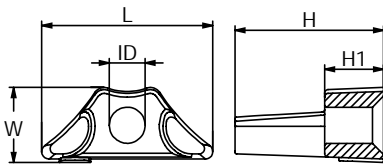

| | PID | LB | KG | | L | W | H | H1 | ID | UPC |
|----|---------------|------|------|----|-----|-----|-----|-----|-----|-----------------|
| AL | CM6881132500A | 0.01 | 0.01 | mm | 23 | 10 | 20 | 8 | 5 | 6 28309 23161 3 |
| MG | CM6881132500M | 0.01 | 0.01 | | | | | | | 6 28309 23175 0 |
| ZN | CM6881132500Z | 0.02 | 0.01 | in | 0.9 | 0.4 | 0.8 | 0.3 | 0.2 | 6 28309 18524 4 |

YAMAHA 40 - 50 -75 -80 -85 - 90 HP

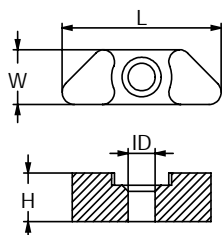

| | PID | LB | KG | | L | W | H | ID | UPC |
|----|---------------|-------|-------|----|-----|-----|-----|-----|-----------------|
| AL | CM6E51132500A | 0.008 | 0.004 | mm | 27 | 9 | 10 | 5 | 6 28309 23162 0 |
| MG | CM6E51132500M | 0.004 | 0.002 | | | | | | 6 28309 23176 7 |
| ZN | CM6E51132500Z | 0.022 | 0.010 | in | 1.1 | 0.4 | 0.4 | 0.2 | 6 28309 23150 7 |



YAMAHA™ anodes

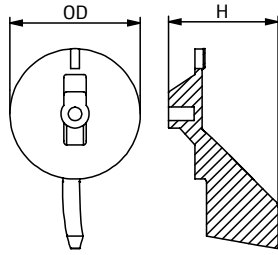

| | PID | LB | KG | | OD | H | THD | UPC |
|----|---------------|------|------|----|------|----|----------|-----------------|
| AL | CM67F4537100A | 0.33 | 0.15 | mm | 91 | 76 | M10x1.25 | 6 28309 23410 2 |
| MG | CM67F4537100M | 0.22 | 0.10 | | | | | 6 28309 23411 9 |
| ZN | CM67F4537100Z | 0.87 | 0.4 | in | 3.58 | 3 | | 6 28309 23412 6 |

YAMAHA V6 - 60 - 70 - 75 - 85 - 90 -115 -130 -150 -175 -200 -225 HP

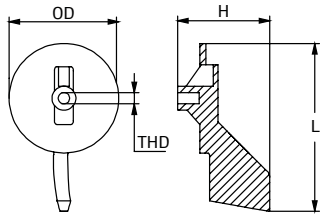

| | PID | LB | KG | | OD | L | H | THD | UPC |
|----|---------------|------|------|----|------|------|------|--------------|-----------------|
| ZN | CM6J94537101Z | 1.14 | 0.52 | mm | 100 | 140 | 85 | M10 x1.25 | 6 28309 10078 0 |
| | | | | in | 3.94 | 5.51 | 3.35 | | |

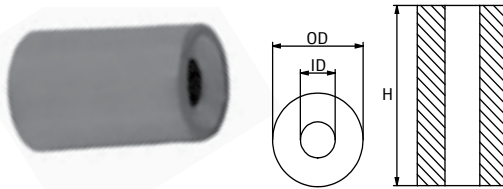

| | PID | LB | KG | | OD | ID | H | UPC |
|----|---------------|-------|-------|----|------|-----|----|-----------------|
| AL | CM6BL1132500A | 0.015 | 0.007 | mm | 13 | 5 | 25 | 6 28309 23215 3 |
| MG | CM6BL1132500M | 0.009 | 0.004 | | | | | 6 28309 23229 0 |
| ZN | CM6BL1132500Z | 0.04 | 0.02 | in | 0.51 | 0.2 | 1 | 6 28309 23198 9 |

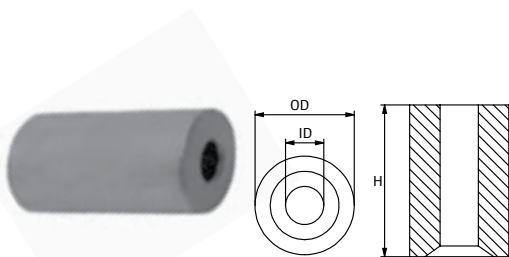

| | PID | LB | KG | | OD | ID | H | UPC |
|----|---------------|-------|-------|----|------|-----|------|-----------------|
| AL | CM68T1132500A | 0.011 | 0.005 | mm | 13 | 5 | 20 | 6 28309 24174 2 |
| MG | CM68T1132500M | 0.006 | 0.003 | | | | | 6 28309 24284 8 |
| ZN | CM68T1132500Z | 0.04 | 0.02 | in | 0.51 | 0.2 | 0.79 | 6 28309 24107 0 |

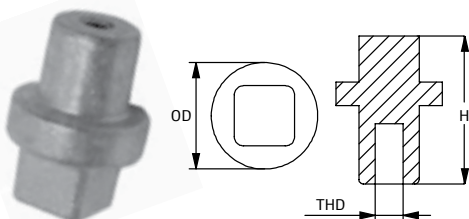

| | PID | LB | KG | | OD | ID | H | UPC |
|----|---------------|-------|-------|----|-----|------|----|-----------------|
| AL | CM67F1132501A | 0.042 | 0.019 | mm | 23 | 32 | M6 | 6 28309 23407 2 |
| MG | CM67F1132501M | 0.026 | 0.012 | | | | | 6 28309 23408 9 |
| ZN | CM67F1132501Z | 0.08 | 0.04 | in | 0.9 | 1.26 | | 6 28309 23409 6 |

YAMAHA™ anodes

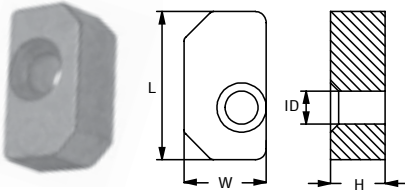

| PID | | LB | KG | | L | W | H | ID | UPC |
|-----|---------------|-------|-------|----|------|------|------|------|-----------------|
| AL | CM63P1132511A | 0.02 | 0.009 | mm | 27 | 15 | 10 | 7 | 6 28309 23880 3 |
| MG | CM63P1132511M | 0.013 | 0.006 | | | | | | 6 28309 23881 0 |
| ZN | CM63P1132511Z | 0.05 | 0.02 | in | 1.06 | 0.59 | 0.39 | 0.28 | 6 28309 23876 6 |

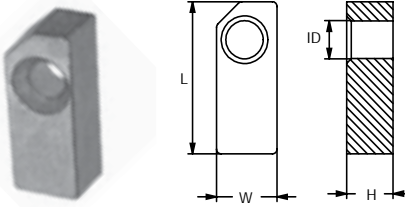

| PID | | LB | KG | | L | W | H | ID | UPC |
|-----|---------------|-------|-------|----|------|------|------|------|-----------------|
| AL | CM63P1132501A | 0.02 | 0.009 | mm | 32 | 13 | 10 | 7 | 6 28309 23398 3 |
| MG | CM63P1132501M | 0.013 | 0.006 | | | | | | 6 28309 23399 0 |
| ZN | CM63P1132501Z | 0.03 | 0.01 | in | 1.26 | 0.51 | 0.39 | 0.28 | 6 28309 23400 3 |

YAMAHA 150 - 200 - 225 - 250 - 300 - 350 HP

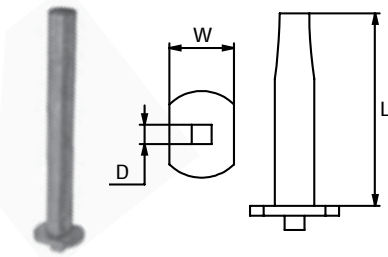

| PID | | LB | KG | | L | W | D | UPC |
|-----|---------------|------|------|----|------|------|------|-----------------|
| ZN | CM61A1132500Z | 0.05 | 0.02 | mm | 70 | 13 | 4 | 6 28309 23397 6 |
| | | | | in | 2.76 | 0.51 | 0.16 | |

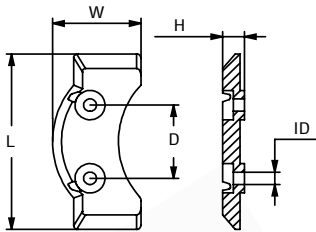

| PID | | LB | KG | | L | W | H | D | ID | UPC |
|-----|---------------|------|------|----|------|------|------|------|------|-----------------|
| ZN | CM6U44537300Z | 0.73 | 0.33 | mm | 120 | 70 | 14 | 50 | 9 | 6 28309 23475 1 |
| | | | | in | 4.72 | 2.76 | 0.55 | 1.97 | 0.33 | |

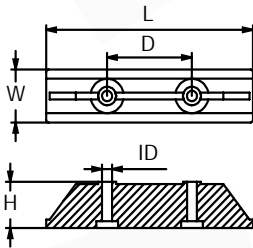

| PID | | LB | KG | | L | W | H | D | ID | UPC |
|-----|---------------|------|------|----|------|------|-----|----|------|-----------------|
| AL | CM6U44525100A | 0.53 | 0.24 | mm | 185 | 46 | 33 | 76 | 9 | 6 28309 23470 6 |
| MG | CM6U44525100M | 0.33 | 0.15 | | | | | | | 6 28309 23471 3 |
| ZN | CM6U44525100Z | 1.51 | 0.68 | in | 7.28 | 1.81 | 1.3 | 3 | 0.35 | 6 28309 23472 0 |

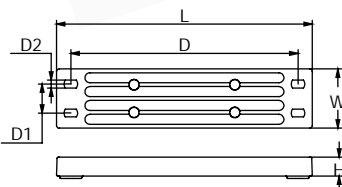

| PID | | LB | KG | | L | W | H | D | D1 | D2 | UPC |
|-----|---------------|------|------|----|------|------|------|--------|------|------|-----------------|
| AL | CM6AW4525100A | 0.56 | 0.25 | mm | 203 | 47 | 15 | 180.35 | 23 | 7.4 | 6 28309 25540 4 |
| MG | CM6AW4525100M | 0.35 | 0.16 | | | | | | | | 6 28309 25545 9 |
| ZN | CM6AW4525100Z | 1.46 | 0.66 | in | 7.99 | 1.85 | 0.59 | 7.1 | 0.90 | 0.29 | 6 28309 25535 0 |

Yamaha OB Engine Anode 6AW-45251-00

YAMAHA™ anodes

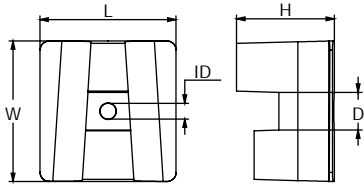

| | PID | LB | KG | | L | W | H | ID | D | UPC |
|----|---------------|------|------|----|------|------|------|------|------|-----------------|
| AL | CM6AW4537300A | 0.93 | 0.42 | mm | 90 | 93 | 35.5 | 11 | 25 | 6 28309 25541 1 |
| MG | CM6AW4537300M | 0.59 | 0.27 | | | | | | | 6 28309 25546 6 |
| ZN | CM6AW4537300Z | 2.42 | 1.09 | in | 3.54 | 3.66 | 1.39 | 0.43 | 0.98 | 6 28309 25536 7 |

Yamaha OB Engine Anode 6AW-45373-00

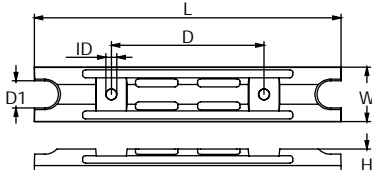

| | PID | LB | KG | | L | W | H | ID | D | D1 | UPC |
|----|---------------|------|------|----|------|------|------|------|------|------|-----------------|
| AL | CM6H14525102A | 0.43 | 0.19 | mm | 203 | 36 | 17 | 7 | 101 | 18 | 6 28309 12657 5 |
| MG | CM6H14525102M | 0.27 | 0.12 | | | | | | | | 6 28309 12658 2 |
| ZN | CM6H14525102Z | 1.08 | 0.49 | in | 7.99 | 1.42 | 0.67 | 0.27 | 3.97 | 0.71 | 6 28309 10076 6 |

Yamaha OB Engine Anode 6H1-45251-02



YAMAHA™ anode kits



| | PID | LB | KG | Contains | Fits | UPC |
|----|------------|------|------|------------------|-----------------------------|-----------------|
| AL | CMY150KITA | 1.28 | 0.58 | CM6G54525101 X 1 | Yamaha 150-200 HP Outboards | 6 28309 12663 6 |
| MG | CMY150KITM | 0.89 | 0.4 | CM6J94537101 X 1 | | 6 28309 15994 8 |



| | PID | LB | KG | Contains | Fits | UPC |
|----|--------------|------|------|------------------|--|-----------------|
| AL | CMY150CRKITA | 1.28 | 0.58 | CM6G54525101 X 1 | Yamaha 150-200 HP Outboards (Counter Rotation) | 6 28309 12664 3 |
| MG | CMY150CRKITM | 0.8 | 0.36 | CM6K14537102 X 1 | | 6 28309 24697 6 |



| | PID | LB | KG | Contains | Fits | UPC |
|----|---------------|------|------|------------------|-----------------------------|-----------------|
| AL | CMY200250KITA | 1.39 | 0.63 | CM6G54525101 X 1 | Yamaha 200-250 HP Outboards | 6 28309 12662 9 |
| MG | CMY200250KITM | 0.97 | 0.44 | CM61A4537100 X 1 | | 6 28309 15995 5 |



| | PID | LB | KG | Contains | Fits | UPC |
|----|-----------------|------|------|------------------|--|-----------------|
| AL | CMYHP200300KITA | 1.3 | 0.59 | CM6G54525101 X 1 | Yamaha High Performance 200 - 300 HP Outboards | 6 28309 12665 0 |
| MG | CMYHP200300KITM | 0.85 | 0.39 | CM69L4537100 X 1 | | 6 28309 23322 8 |

ALL KITS INCLUDE FASTENING HARDWARE, INSTALLATION INSTRUCTIONS, AND ALL OF THE ANODES REQUIRED FOR 100% PROTECTION.



YAMAHA™ anode kits



| | PID | LB | KG | Contains | Fits | UPC |
|----|---------------|------|-------|--------------------------------------|------------------------|-----------------|
| AL | CMY300350KITA | 1.87 | 0.846 | CM6AW4525100 X 1 CM6AW4537300 X 1 | 300-350 HP Outboard | 6 28309 26013 2 |
| MG | CMY300350KITM | 1.35 | 0.614 | | | 6 28309 26035 4 |
| ZN | CMY300350KITZ | 4.24 | 1.924 | | | 6 28309 25989 1 |

YAMAHA MARINER™ anode kits



| | PID | LB | KG | Contains | Fits | UPC |
|----|-------------|------|------|--------------------------------------|-------------------|-----------------|
| AL | CMY6090KITA | 1.16 | 0.52 | CM6884537102 X 1 CM6H14525102 X 1 | Yamaha 60-90HP | 6 28309 24973 1 |
| MG | CMY6090KITM | 0.87 | 0.39 | | | 6 28309 24974 8 |
| ZN | CMY6090KITZ | 2.43 | 1.10 | | | 6 28309 24975 5 |



| | PID | LB | KG | Contains | Fits | UPC |
|----|-------------|------|------|--|-----------------------|-----------------|
| AL | CMY4060KITA | 0.92 | 0.42 | CM65W4525100 X 3 CM67C4525100 X 1 CM67C4537100 X 1 | Yamaha 4T 40-60 HP | 6 28309 24970 0 |
| MG | CMY4060KITM | 0.74 | 0.34 | | | 6 28309 24971 7 |
| ZN | CMY4060KITZ | 1.79 | 0.81 | | | 6 28309 24972 4 |



| | PID | LB | KG | Contains | Fits | UPC |
|----|-------------|------|------|--|-------------------|-----------------|
| AL | CMY4050KITA | 1.08 | 0.49 | CM6644537101 X 1 CM65W4525100 X 1 CM63D4525101 X 1 CM67C4525100 X 1 CM6881132500 X 1 | Yamaha 40-50HP | 6 28309 26015 6 |
| MG | CMY4050KITM | 0.75 | 0.34 | | | 6 28309 26037 8 |
| ZN | CMY4050KITZ | 2.49 | 1.13 | | | 6 28309 25991 4 |



| | PID | LB | KG | Contains | Fits | UPC |
|----|--------------|------|------|--|--------------------|-----------------|
| AL | CMY80100KITA | 0.99 | 0.45 | CM6H14525102 X 1 CM67F4537100 X 1 CM67F1132500 X 1 | Yamaha 80-100HP | 6 28309 26016 3 |
| MG | CMY80100KITM | 0.68 | 0.31 | | | 6 28309 26038 5 |
| ZN | CMY80100KITZ | 2.27 | 1.03 | | | 6 28309 25992 1 |

**ALL KITS INCLUDE FASTENING HARDWARE, INSTALLATION INSTRUCTIONS,
AND ALL OF THE ANODES REQUIRED FOR 100% PROTECTION.**

YANMAR™ anodes

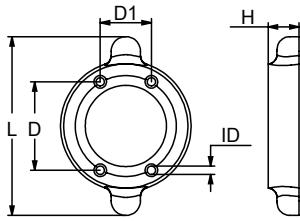

| | PID | LB | KG | | L | D | D1 | ID | H | UPC |
|----|----------------|------|------|----|-----|-----|------|-----|------|-----------------|
| ZN | CM19642002652Z | 1.88 | 0.85 | mm | 148 | 73 | 42 | 7 | 7 | 6 28309 11550 0 |
| | | | | in | 5.8 | 2.9 | 1.67 | 0.3 | 0.26 | |

YANMAR - SD 20 - 30 - 40 - 50 - 60

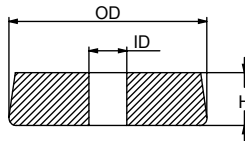

| | PID | LB | KG | | OD | ID | H | UPC |
|----|----------|------|-----|----|-----|------|-----|-----------------|
| ZN | SGMA015Z | 0.44 | 0.2 | mm | 53 | 10 | 14 | 6 28309 18309 7 |
| | | | | in | 2.1 | 0.39 | 0.5 | |

70-85 HP

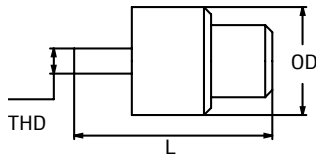

| | PID | LB | KG | | L | OD | THD | UPC |
|----|----------|-------|-------|----|-----|-----|-----|-----------------|
| ZN | SGYN068Z | 0.312 | 0.142 | mm | 55 | 30 | M8 | 6 28309 18318 9 |
| | | | | in | 2.2 | 1.2 | | |

8-10 HP W/ THREADSTEEL CORE

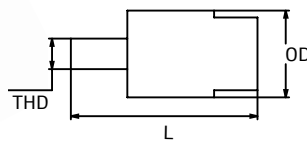

| | PID | LB | KG | | L | OD | THD | UPC |
|----|----------|-------|-------|----|------|------|-----|-----------------|
| ZN | SGYN069Z | 0.143 | 0.065 | mm | 43 | 20 | M8 | 6 28309 18319 6 |
| | | | | in | 1.7 | 0.8 | | |
| ZN | SGYN224Z | 0.097 | 0.044 | mm | 36 | 20 | M8 | 6 28309 18320 2 |
| | | | | in | 1.42 | 0.80 | | |

YANMAR 8 - 12 HP W/ THREADSTEEL CORE

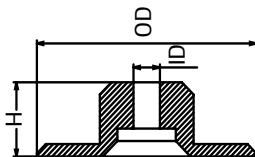

| | PID | LB | KG | | OD | ID | H | UPC |
|----|----------|------|------|----|-----|------|-----|-----------------|
| ZN | SGYN261Z | 0.42 | 0.19 | mm | 75 | 9 | 24 | 6 28309 18321 9 |
| | | | | in | 2.9 | 0.35 | 0.9 | |

YANMAR SERIES



YANMAR™ anodes

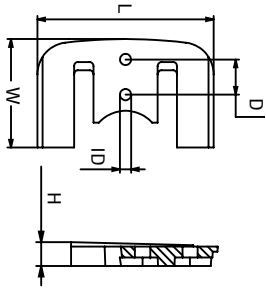

| | PID | LB | KG | | L | W | D | ID | H | UPC |
|----|----------|----|------|----|-----|------|------|------|------|-----------------|
| ZN | SGYN245Z | 2 | 0.91 | mm | 178 | 108 | 35 | 11 | 17 | 6 28309 22481 3 |
| | | | | in | 7 | 4.25 | 1.38 | 0.44 | 0.68 | |

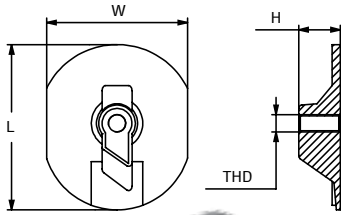

| | PID | LB | KG | | L | W | D | THD | UPC |
|----|----------|------|------|----|------|------|------|------|-----------------|
| ZN | SGYN744Z | 0.68 | 0.31 | mm | 96 | 82 | 24 | M10 | 6 28309 22483 7 |
| | | | | in | 3.79 | 3.23 | 0.96 | x1.5 | |

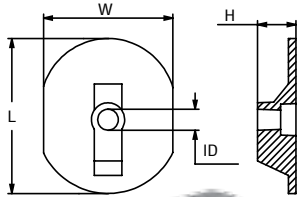

| | PID | LB | KG | | L | W | H | ID | UPC |
|----|----------|------|------|----|------|------|------|------|-----------------|
| ZN | SGYN745Z | 0.64 | 0.29 | mm | 96 | 82 | 24 | 12 | 6 28309 22484 4 |
| | | | | in | 3.79 | 3.23 | 0.96 | 0.47 | |

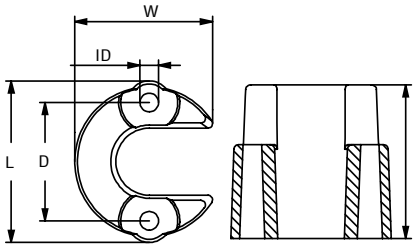

| | PID | LB | KG | | L | W | H | D | ID | UPC |
|----|----------|------|------|----|------|------|------|------|------|-----------------|
| ZN | SGYN746Z | 0.61 | 0.28 | mm | 52.3 | 44.7 | 49.5 | 38.1 | 6.09 | 6 28309 22485 1 |
| | | | | in | 2.06 | 1.76 | 1.95 | 1.5 | 0.24 | |

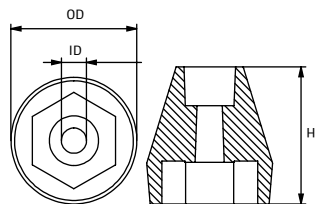

| | PID | LB | KG | | OD | ID | H | UPC |
|----|----------|------|------|----|------|------|------|-----------------|
| ZN | SGYN747Z | 1.13 | 0.51 | mm | 54 | 11 | 61 | 6 28309 22486 8 |
| | | | | in | 2.11 | 0.44 | 2.39 | |

YANMAR™ anode kits

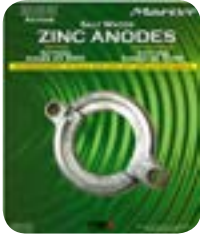

| | PID | LB | KG | Contains | Fits | UPC |
|----|-------------------|-----|------|-------------------|---|-----------------|
| ZN | CM19644002660KITZ | 0.8 | 0.36 | CM19644002660 X 1 | Yanmar SD20, SD30, SD31, SD40, SD50 and SD60 Saildrives | 6 28309 12719 0 |



| PID | Fits | UPC |
|---------------|---|-----------------|
| CM19644002690 | Yanmar SD20, SD30, SD31, SD40, SD50 and SD60 Saildrives | 6 28309 23243 6 |

ADAPTER MOUNTING KIT: Enables the installation of a split ring anode onto the lower units of Yanmar SD20, SD30, SD31, SD40, SD50 and SD60 saildrives. Contains: 2 x Stainless Steel Plates, 4 x Screw DIN7991 (countersink w/hex socket head) M6 x 1.0 - 16, 2 x Screw DIN912 (Hex Socket Head) M8 x 1.25 - 20



| | PID | LB | KG | Contains | Fits | UPC |
|----|------------|------|------|---|---|-----------------|
| ZN | SGYNZT350Z | 6.14 | 2.79 | SGYN245 X 1, SGYN745 X 1 SGYN747 X 1, SGYN744 X 1 SGYN746 X 2 | Yanmar SD20, SD30, SD31, SD40 and SD50 Saildrives | 6 28309 22487 5 |



| | PID | LB | KG | Contains | Fits | UPC |
|----|-------------------|------|------|-------------------------|---------------------|-----------------|
| ZN | CM11977392600KITZ | 0.88 | 0.40 | CME2Z X 1 CME1FZ X 4 | Yanmar 119773-92600 | 6 28309 25969 3 |