

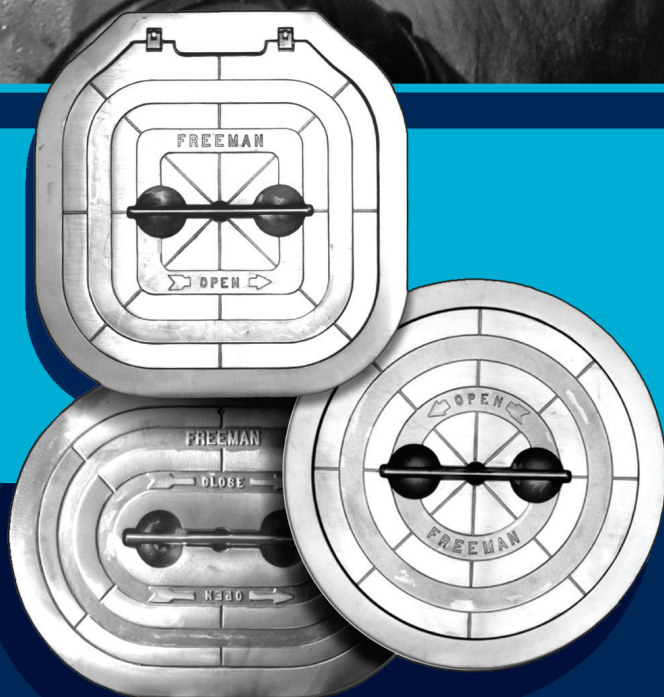

*First in the
Relentless Pursuit
of SAFE, INNOVATIVE
PRODUCTS for
SEA, LAND & AIR*



AdvanTec
Marine

FREEMAN The first name in
PERFORMANCE, EXPERIENCE & SERVICE
for watertight deck hatches...

CERTIFICATES AND ACCEPTANCES

AdvanTec's Freeman cast hatch line has various approvals and certifications. Our hatches have been granted American Bureau of Shipping (ABS) Product Design Assessment Certification for 109 different models. Each of these models can be used on a number of ABS classed vessels in locations specified in the design assessment.

AdvanTec Marine constantly monitors maritime regulations, standards and classification society activities related to closure approvals.

AdvanTec Marine closures have received specific intended use acceptance by:

- ABS - American Bureau of Shipping
- DNV - Det Norske Veritas
- LR - Lloyds Register of Shipping
- GL - Germanischer Lloyds
- BV - Bureau Veritas
- MCA - Maritime Coastguard Agency
- RS - Russian Maritime Register of shipping
- RINA - RINA S.P.A., Italy
- CRS - Croatian Registry of Shipping
- USCG - US Coast Guard
- CCG - Canadian Coast Guard (Transport Canada)
- ABYC - American Boat & Yacht Council

• APPROVALS AT A GLANCE

**ABS - type approval,
certificate no. 13-HS1082451-PDA**

**Lloyd's Register - type approval
certificate no. 03/00088(E3) & 9/60003(E1)**

U.S. Coast Guard,
CE, ISO-12216 compliant.

Approvals have been awarded and may be obtained for specific intended uses. AdvanTec Cast Hatches are currently in use on Coast Guard vessels and Naval craft of all types.

AdvanTec Marine can assist with specific intended use applications.

Compliance with ISO
9001:2015
Certified by TÜV Rheinland
Of North America, Inc.



AdvanTec Marine QUALITY. CAPABILITY.

ADVANTEC MARINE, QUALITY POLICY STATEMENT

- Consistently meet or exceed our customer's expectation for product safety, quality and performance.
- Be the very best in the world at what we do, by continuous improvements
- Provide employee training to better serve our customers and to support personal growth.

ADVANTEC MARINE CAPABILITIES

- Commercial, Fishing, Passenger, Supply, Military, and Mega-Yacht Projects
- Comprehensive In-house Capabilities – Design, Engineering, Tooling, Foundry, Machining, Fabrication, Assembly, Paint, Testing, Service, Parts
- Specified by Leading Naval Architects and Builders Worldwide
- International Standards – Recognized by Leading Agencies and Societies
- Marine, Rail, Civil, Industrial



Over 350 self righting vessels 100% completely outfitted with AdvanTec hatches, doors, windows & portlights. The people you trust, trust AdvanTec Marine.

ISO 9001:2015

FREEMAN HATCHES HAVE MORE QUICK-ACTING FLUSH HATCH EXPERIENCE, MODELS AND FEATURES THAN ANY MANUFACTURER

AdvanTec Marine's Freeman hatches are used on a wide variety of fishing boats, tugs, barges, research vessels, offshore tenders, rescue craft and other workboats. The Freeman hatch is designed for new boats, for replacing other hatches in standard openings, or for improving existing craft.

The hatches are fast acting and easy to use. Simply grasp the handle and pull, the shaft slides into place, and with less than a quarter turn, completely disengages the locking mechanism. The dogs and linked handle do the work smoothly in just a second.

Our easy lift system allows simple removal. With the locking mechanism disengaged, the hatch is resting on the deck ring and can be lifted out with one hand.

- **TOP VALUE**
- **RELIABLE**
- **VERSATILE**
- **EASY LIFT**
- **FAST ACTING**
- **LOW MAINTENANCE**

- Evenly spaced dogging arms exert uniform force on the cover plate.
- Handle position shows when dogging arms are engaged or disengaged.
- Handle is always attached. Hatch and handle fit flush with the deck with the handle in a recessed locked position.
- Watertight hatches are designed to seal up to 30 foot intermittent head, the double-sealing gasket seals tighter under pressure.
- Versatile installation, hatches can be installed in steel, aluminum, wood, or fiber glass decks.
- Complete units include aluminum or steel mounting rings for bolt-in or weld-in installations.
- Dogging mechanism assures smooth consistent action; no binding or jamming.
- Quick-acting dogging eliminates over or under tightening; hatch operates the same each time.

AdvanTec Marine's Freeman Hatches
SERVICE. VALUE. EXPERIENCE.

HINGED HATCHES

For hinged models the unique hinging device allows the hatch to be opened more than 180° and "floats" when the hatch is closed to facilitate a tighter seal. Round hatches 18" and larger, and all oval and square hatches with aluminum covers are available hinged from the factory.

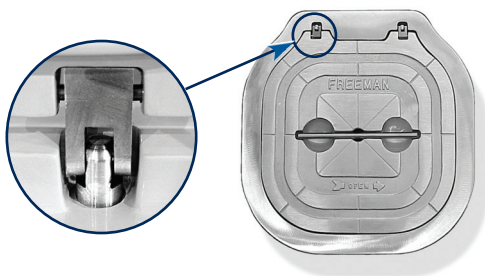

Close-up view of standard Freeman "floating" hinge installed on hatch assembly.



• **CONCEALED YOKE HINGE**
(optional, selected models)

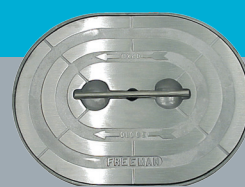

• **LIFT OUT**

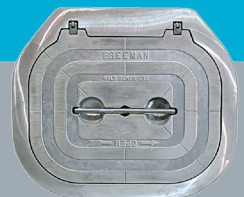

• **SURFACE HINGES**

✓ **Buy America Act Compliant (52.225-1)**



ISO 9001:2015

TWO IMPORTANT FEATURES DISTINGUISH THE FREEMAN CAST HATCH FROM OTHER DESIGNS

- **Built in T-handle**
- **Easy Operating Dogging Mechanism**

The standard pocketed, stainless steel T-handle is built in, permanently part of the hatch. Grasp the handle and pull, the shaft slides up into place, and with less than a quarter of a turn the locking mechanism completely disengages. The alignment of the handle shows when dogging arms are engaged or disengaged.

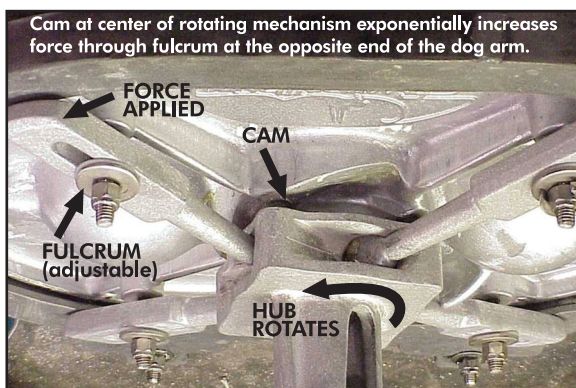

Evenly spaced dogging arms (either 3, 4 or 8 depending on size of hatch) exert uniform sealing pressure on the cover plate. The unique design, fit, and adjustability of Freeman's dogging mechanism assure smooth, consistent action; no binding or jamming of parts.



Each dog is adjustable to insure equal tension (torque) on gasket sealing surface

Adjusted to proper tension, a Freeman hatch can't be over or under tightened by mistake.

KNIFE-EDGE OR COMPRESSION SEALING?

• Compression Seal 2400 Series Hatches

These hatches have easy-to-clean spigots, feature long gasket life, and are economical to purchase.

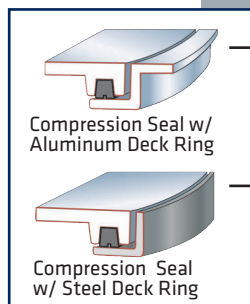

- Aluminum Deck Rings are intended to be weld installed into aluminum decks and bolt installed into other deck materials.

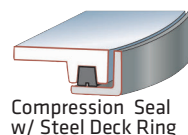

- Steel Deck Rings are to be weld installed into steel decks only.
- Watertight seal to 30 foot intermittent head, continuous 10 foot head top-loaded pressure (on properly installed and adjusted hatch assemblies).

• Knife-edge Seal 2400 Series Hatches

These hatches feature a coaming with drain gutter and an aggressive sealing rim edge. A drain fitting can be installed to minimize water from entering enclosure when hatch is initially opened.

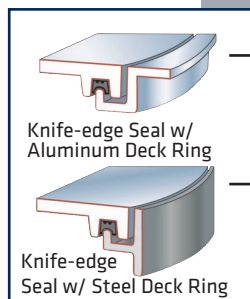

- Aluminum Deck Rings are intended to be weld installed into aluminum decks and bolt installed into other deck materials.

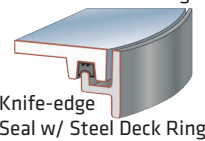

- Steel Deck Rings are to be weld installed into steel decks only.

TYPICAL HATCH COVER ASSEMBLY

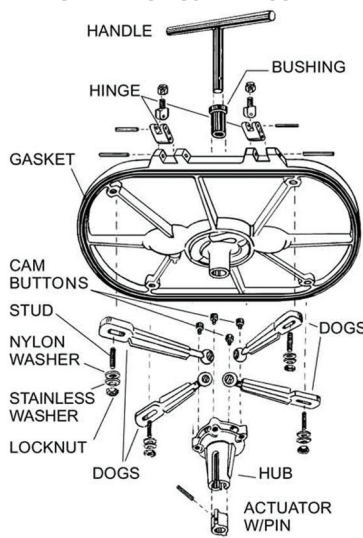

• Stainless Steel Deck Rings

Available on most models, see steel deck rings for dimensions.

• Replacement Parts

Gaskets for periodic scheduled maintenance or parts to repair a damaged hatch are always available. AdvanTec Manufacturing USA and its distributors keep substantial inventories of parts for immediate shipment.

Parts information and where-to-buy:

www.freemanmarine.com
www.advantecstore.com

Shape and optional hinge vary by model

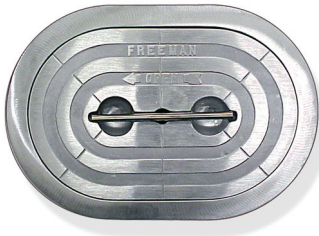

15" x 24" Oval lift-out,
Aluminum ring

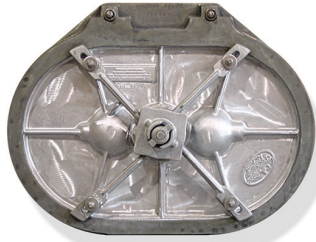

15" x 24" Oval hinged,
Steel ring, Inside view

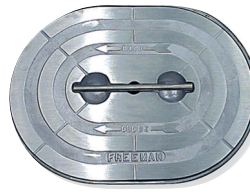

15" x 24" Oval lift-out,
Steel ring

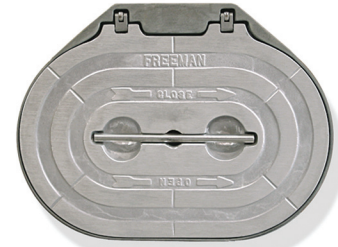

15" x 24" Oval hinged,
Steel ring

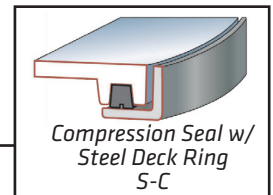
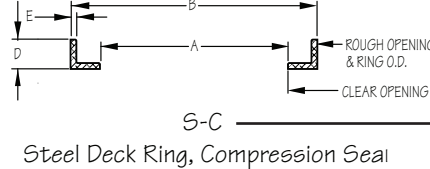
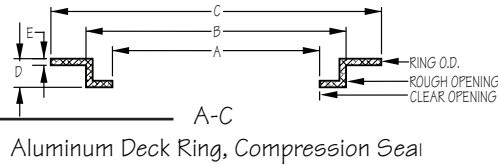
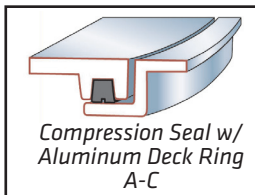
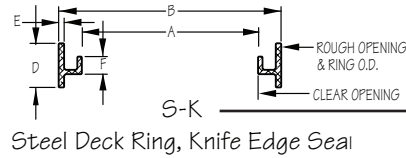
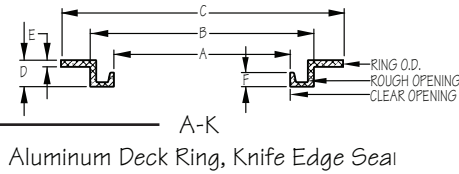

PART NO	SIZE	SHAPE	STYLE	RING	DIMENSIONS										MECHANISM	ASSEMBLY WEIGHT					
					CLEAR OPENING		ROUGH OPENING*		OVERALL			COVER	OVERALL			STD MATERIAL	DOG Qty	LBS	KGS		
					A (in)	A (mm)	B (in)	B (mm)	C (in)	C (mm)	D		E	F						THKNESS	(in)
2431-0002	12" x 18"	Oval	Lift-Out	A-C	12.0 x 18.0	305 x 457	15.0 x 21.0	381 x 533	18.8 x 24.8	478 x 630	1.5	0.31		ALUM	0.28	14.1 x 20.3	358 x 516	ALUM ALLOY	4	29	13.2
2431-0003	12" x 18"	Oval	Lift-Out	S-C	12.0 x 18.0	305 x 457	14.8 x 19.8	376 x 503			1.3	0.25		ALUM	0.29	14.1 x 20.3	358 x 516	ALUM ALLOY	4	30	13.6
2471-0002	12" x 18"	Oval	Hinged	A-C	12.0 x 18.0	305 x 457	15.0 x 21.0	381 x 533	18.8 x 24.8	478 x 630	1.5	0.31		ALUM	0.28	14.1 x 20.3	358 x 516	ALUM ALLOY	4	31	14.1
2471-0003	12" x 18"	Oval	Hinged	S-C	12.0 x 18.0	305 x 457	14.8 x 20.6	376 x 503			1.3	0.25		ALUM	0.29	14.1 x 20.3	358 x 516	ALUM ALLOY	4	31	14.1
2433-0002	15" x 24"	Oval	Lift-Out	A-C	14.8 x 23.7	376 x 603	17.7 x 26.7	450 x 677	21.3 x 30.3	541 x 770	1.5	0.25		ALUM	0.22	16.3 x 25.9	414 x 658	ALUM ALLOY	4	35	15.9
2433-0003	15" x 24"	Oval	Lift-Out	S-C	14.8 x 23.7	376 x 603	17.4 x 26.5	442 x 673			1.3	0.25		ALUM	0.22	16.3 x 25.9	414 x 658	ALUM ALLOY	4	37	16.8
2434-0002	15" x 24"	Oval	Lift-Out	A-K	15.2 x 24.2	386 x 615	17.9 x 26.9	455 x 684	21.0 x 30.0	533 x 762	1.6	0.31	0.6	ALUM	0.21			ALUM ALLOY	4	35	15.9
2434-0003	15" x 24"	Oval	Lift-Out	S-K	15.2 x 24.2	386 x 615	17.7 x 26.7	450 x 678			2.5	0.31	0.25	ALUM	0.21			ALUM ALLOY	4	54	24.5
2473-0002	15" x 24"	Oval	Hinged	A-C	14.6 x 23.5	371 x 597	17.6 x 26.5	447 x 673	21.6 x 30.5	549 x 775	1.5	0.31		ALUM	0.2	16.3 x 25.9	414 x 658	ALUM ALLOY	4	37	16.8
2473-0003	15" x 24"	Oval	Hinged	S-C	14.6 x 23.5	371 x 597	17.6 x 26.5	447 x 673			1.3		0.25	ALUM	0.2	16.3 x 25.9	414 x 658	ALUM ALLOY	4	38	17.2
2474-0002	15" x 24"	Oval	Hinged	A-K	15.2 x 24.2	388 x 615	17.2 x 26.2	437 x 665	21.0 x 30.0	533 x 762	1.6	0.31	0.6	ALUM	0.21			ALUM ALLOY	4	35	15.9
2474-0003	15" x 24"	Oval	Hinged	S-K	15.2 x 24.2	388 x 615	17.9 x 26.69*	454 x 678*			2.5	0.31	0.25	ALUM	0.21			ALUM ALLOY	4	60	27.2
2483-0107	15" x 24"	Oval	Lift-Out	S-K	15.1 x 24.1	384 x 613	17.5 x 26.5	445 x 673			1.5	0.25		DUCT IRON	0.38	16.9 x 25.6	429 x 650	ALUM ALLOY	4	85	28.6
2435-0002	19" x 26"	Oval	Lift-Out	A-K	19.2 x 26.2	488 x 665	21.2 x 28.2	538 x 716	25.0 x 32.0	635 x 813	1.6	0.31	0.6	ALUM	0.29			ALUM ALLOY	4	43	19.5
2435-0003	19" x 26"	Oval	Lift-Out	S-K	19.2 x 26.2	488 x 665	21.7 x 28.7	551 x 729			2.5	0.31	0.25	ALUM	0.29			ALUM ALLOY	4	61	27.7
2475-0002	19" x 26"	Oval	Hinged	A-K	19.2 x 26.2	488 x 665	21.2 x 28.2	538 x 716	27.2 x 32.4	691 x 823	1.6	0.31	0.6	ALUM	0.29			ALUM ALLOY	4	44	20
2475-0003	19" x 26"	Oval	Hinged	S-K	19.2 x 26.2	488 x 665	21.7 x 28.7	551 x 729			2.5	0.31	0.25	ALUM	0.29			ALUM ALLOY	4	67	30

*DOES NOT INCLUDE HINGE POCKETS



30" Round lift-out,
Steel ring



8" Round lift-out, Aluminum ring



18" Round lift-out,
Steel ring

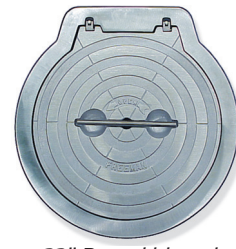

22" Round hinged,
Aluminum ring

PART NO	SIZE	SHAPE	STYLE	RING	DIMENSIONS													MECHANISM		ASSEMBLY WEIGHT		
					CLEAR OPENING		ROUGH OPENING*		OVERALL							OVERALL		STD MATERIAL	DOG Qty	LBS	KGS	
					A (in)	A (mm)	B (in)	B (mm)	C (in)	C (mm)	D	E	F	MTRL	THKNESS	in	mm					
2401-0002	8"	Round	Lift-Out	A-C	7.9	201	10.3	262	12	305	1	0.31		ALUM	0.23	9.8	249	ALLUM ALLOY	3	8	3.6	
2402-0002	12"	Round	Lift-Out	A-C	11.9	302	14.8	376	17.4	442	1.3	0.31		ALUM	0.19	13.9	353	ALLUM ALLOY	3	13	5.9	
2402-0003	12"	Round	Lift-Out	S-C	11.9	302	14.5	368			1.3	0.25		ALUM	0.19	13.9	353	ALLUM ALLOY	3	16	7.3	
2403-0002	15"	Round	Lift-Out	A-C	15	381	17.8	452	12.5	546	1.3	0.31		ALUM	0.29	17	432	ALLUM ALLOY	3	23	10.4	
2403-0003	15"	Round	Lift-Out	S-C	15	381	17.6	447			1.3	0.25		ALUM	0.29	17	432	ALLUM ALLOY	3	26	11.8	
2404-0002	18"	Round	Lift-Out	A-C	18	457	20.9	530	24.5	622	1.4	0.31		ALUM	0.26	20	508	ALLUM ALLOY	3	30	13.6	
2404-0003	18"	Round	Lift-Out	S-C	18	457	20.5	521			1.3	0.25		ALUM	0.26	20	508	ALLUM ALLOY	3	32	14.5	
2405-0002	18"	Round	Lift-Out	A-K	18	457	20	508	24	607	1.5	0.38	0.8	ALUM	0.24			ALLUM ALLOY	3	38	17.2	
2405-0003	18"	Round	Lift-Out	S-K	18	457	20.6	523			2.5	0.31	1	ALUM	0.24			ALLUM ALLOY	3	36	16.3	
2441-0002	18"	Round	Hinged	A-C	18	457	20.9	530	24.5	622	1.6	0.27		ALUM	0.38	20	508	ALLUM ALLOY	3	35	15.9	
2441-0003	18"	Round	Hinged	S-C	18	457	20.8	528			1.3	0.25		ALUM	0.38	20	508	ALLUM ALLOY	3	38	17.2	
2442-0002	18"	Round	Hinged	A-K	18	457	20	508	24	607	1.5	0.38	0.8	ALUM	0.24			ALLUM ALLOY	3	39	17.7	
2442-0003	18"	Round	Hinged	S-K	18	457	20.6	523			2.5	0.31	1	ALUM	0.24			ALLUM ALLOY	3	42	19.1	
2481-0107	18"	Round	Lift-Out	S-C	18	457	20.5	521			1.5	0.25		DUCT IRON	0.41	19.9	505	STAIN STEEL	3	75	34	
2406-0002	20"	Round	Lift-Out	A-C	19.8	503	22.8	579	26.5	673	1.3	0.31		ALUM	0.26	21.9	556	ALLUM ALLOY	4	36	16.3	
2406-0003	20"	Round	Lift-Out	S-C	19.8	503	22.4	569			1.3	0.25		ALUM	0.26	21.9	556	ALLUM ALLOY	4	37	16.8	
2407-0002	20"	Round	Lift-Out	A-K	20	508	22	559	26	660	1.4	0.38	0.7	ALUM	0.35			ALLUM ALLOY	4	44	20	
2407-0003	20"	Round	Lift-Out	S-K	20	508	22.6	574			2.5	0.31	1	ALUM	0.35			ALLUM ALLOY	4	41	18.6	
2443-0002	20"	Round	Hinged	A-C	19.6	498	22.8	579	26.5	673	1.7	0.4		ALUM	0.29	21.9	556	ALLUM ALLOY	4	44	20	
2443-0003	20"	Round	Hinged	S-C	19.6	498	22.4	569			1.3	0.25		ALUM	0.29	21.9	556	ALLUM ALLOY	4	47	21.3	
2444-0002	20"	Round	Hinged	A-K	20	508	22	559	26	660	1.4	0.38	0.7	ALUM	0.35			ALLUM ALLOY	4	45	20.4	
2444-0003	20"	Round	Hinged	S-K	20	508	22.6	579			2.5	0.31	1	ALUM	0.35			ALLUM ALLOY	4	48	21.8	

*DOES NOT INCLUDE HINGE POCKETS

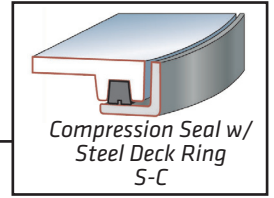
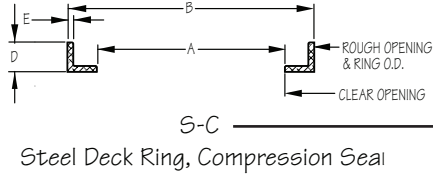
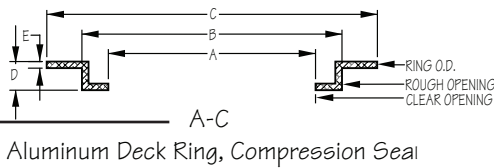
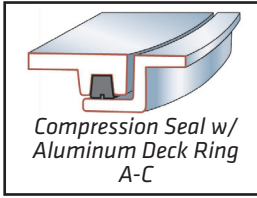
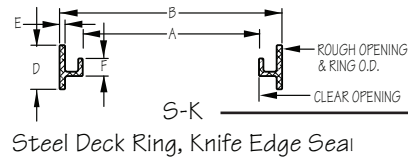
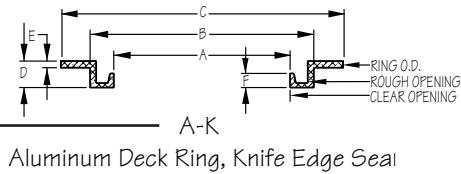

PART NO	SIZE	SHAPE	STYLE	RING	DIMENSIONS							COVER				MECHANISM	ASSEMBLY WEIGHT				
					CLEAR OPENING		ROUGH OPENING*		OVERALL					OVERALL			STD MATERIAL	DOC Qty	LBS	KGS	
					A (in)	A (mm)	B (in)	B (mm)	C (in)	C (mm)	D	E	F	MTRL	THKNSS						in
2408-0002	22"	ROUND	LIFT-OUT	A-C	22	559	24.8	630	28.5	724	1.6	0.31		ALUM	0.31	24	610	ALUM ALLOY	4	39	17.7
2408-0003	22"	ROUND	LIFT-OUT	S-C	22	559	24.6	625			1.5	0.25		ALUM	0.31	24	610	ALUM ALLOY	4	40	18.1
2411-0002	24"	ROUND	LIFT-OUT	A-C	23.3	592	26.6	676	30.5	775	1.4	0.31		ALUM	0.37	25.8	665	ALUM ALLOY	4	52	23.6
2411-0003	24"	ROUND	LIFT-OUT	S-C	23.3	592	26.5	673			1.5	0.25		ALUM	0.37	25.8	665	ALUM ALLOY	4	54	24.5
2412-0002	24"	ROUND	LIFT-OUT	A-K	24.1	612	26.1	663	30.6	777	1.6	0.38	0.6	ALUM	0.42			ALUM ALLOY	4	65	29.5
2412-0003	24"	ROUND	LIFT-OUT	S-K	24.1	612	26.7	678			2.5	0.31	1.0	ALUM	0.42			ALUM ALLOY	4	59	28.8
2447-0002	24"	ROUND	HINGED	A-C	23.4	594	26.4	671	30.5	775	1.7	0.4		ALUM	0.41	25.8	665	ALUM ALLOY	4	59	28.8
2447-0003	24"	ROUND	HINGED	S-C	23.4	594	26.5	673			1.5	0.25		ALUM	0.41	25.8	665	ALUM ALLOY	4	62	28.1
2448-0002	24"	ROUND	HINGED	A-K	24.1	612	26.1	663	30.6	777	1.6	0.38	0.6	ALUM	0.42			ALUM ALLOY	4	66	29.9
2448-0003	24"	ROUND	HINGED	S-K	24.1	612	26.7	678			2.5	0.31	1.0	ALUM	0.42			ALUM ALLOY	4	65	29.5
2482-0107	24"	ROUND	LIFT-OUT	S-C	23.3	592	26.5	673			1.5	0.25		DUCT IRON	0.36	25.8	655	STAIN STEEL	4	110	49.9
2415-0006	30"	ROUND	LIFT-OUT	A-C	30	762	33.5	851	37.3	947	1.4	0.31		ALUM	0.41	32.5	826	STAIN STEEL	4	81	36.7
2415-0007	30"	ROUND	LIFT-OUT	S-C	30	762	33.3	846			1.3	0.25		ALUM	0.39	32.5	826	STAIN STEEL	4	87	39.5
2452-0006	30"	ROUND	HINGED	A-C	30	762	33.5	851	37.3	947	1.7	0.4		ALUM	0.46	32.5	826	STAIN STEEL	4	82	37.2
2452-0007	30"	ROUND	HINGED	S-C	30	762	33.3	846			1.5	0.25		ALUM	0.49	32.5	826	STAIN STEEL	4	118	53.5

*DOES NOT INCLUDE HINGE POCKETS



photo by Alicia Myrick



22" Square hinged, Inside view

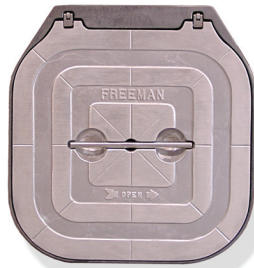

22" Square hinged, Steel ring



18" x 24" Rectangular Hinged, Aluminum ring



22" Square hinged, Aluminum ring



Knife Edge Seal w/ Aluminum Deck Ring A-K

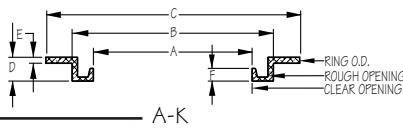

Aluminum Deck Ring, Knife Edge Seal

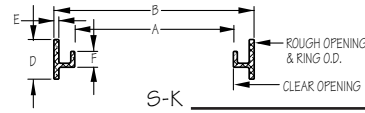

Steel Deck Ring, Knife Edge Seal



Knife Edge Seal w/ Steel Deck Ring S-K

PART NO	SIZE	SHAPE	STYLE	RING	DIMENSIONS										MECHANISM		ASSEMBLY WEIGHT		
					CLEAR OPENING		ROUGH OPENING*		OVERALL				COVER		STD MATERIAL	DOC Qty	LBS	KGS	
					A (in)	A (mm)	B (in)	B (mm)	C (in)	C (mm)	D	E	F	MTRL					THKNESS
2421-0002	18"x24"	Rectangle	Lift-Out	A-K	18.0x24.0	457x610	20.5x26.5	521x673	24.5x30.5	622x775	1.6	0.38	0.7	ALUM	0.22	ALUM ALLOY	4	36	16.3
2421-0003	18"x24"	Rectangle	Lift-Out	S-K	18.0x24.0	457x610	20.5x26.5	521x673			2.5	0.31	0.9	ALUM	0.22	ALUM ALLOY	4	61	27.7
2461-0002	18"x24"	Rectangle	Hinged	A-K	18.0x24.0	457x610	20.5x26.5	521x673	24.5x30.5	622x775	1.6	0.38	0.7	ALUM	0.22	ALUM ALLOY	4	36	16.3
2461-0003	18"x24"	Rectangle	Hinged	S-K	18.0x24.0	457x610	20.5x26.4	521x673			2.5	0.31	0.9	ALUM	0.22	ALUM ALLOY	4	61	27.7
2436-0002	24"x28"	Rectangle	Lift-Out	A-K	24.6x28.6	625x727	27.5x31.5	699x799	31.2x35.2	793x894	1.6	0.38	0.7	ALUM	0.22	ALUM ALLOY	4	61	27
2436-0003	24"x28"	Rectangle	Lift-Out	S-K	24.6x28.6	625x727	27.5x31.5	699x799			2.5	0.31	0.9	ALUM		ALUM ALLOY	4	83	37.4
2476-0002	24"x28"	Rectangle	Hinged	A-K	24.6x28.4	629x724	29.6x31.4	752x797	33.1x34.9	840x887	1.6	0.38	0.7	ALUM		ALUM ALLOY	4	62	28.1
2476-0003	24"x28"	Rectangle	Hinged	S-K	24.6x28.4	629x724	29.6x31.4	752x797			2.5	0.31	0.9	ALUM		ALUM ALLOY	4	84	37.9
2429-0002	30"x36"	Rectangle	Lift-Out	A-K	30.5x36.5	775x927	32.8x38.8	834x987	36.3x42.3	923x1075	2.5	0.31	0.9	ALUM	0.3	ALUM ALLOY	8	102	46.3
2429-0003	30"x36"	Rectangle	Lift-Out	S-K	30.5x36.5	775x927	33.5x39.5	850x1003			2.5	0.31	0.9	ALUM	0.3	ALUM ALLOY	8	119	54
2469-0002	30"x36"	Rectangle	Hinged	A-K	30.6x36.6	776x930	32.8x38.8	834x987	38.1x42.3	967x1075	1.6	0.38	0.7	ALUM		ALUM ALLOY	8	93	42.4
2469-0003	30"x36"	Rectangle	Hinged	S-K	30.0x36.0	762x914	33.5x39.5	850x1003			2.5	0.31	0.9	ALUM		ALUM ALLOY	8	130	59
2422-0002	20"x20"	Square	Lift-Out	A-K	20.3x20.3	517x517	22.8x22.8	579x579	26.8x26.8	681x681	1.6	0.38	0.7	ALUM		ALUM ALLOY	4	43	19.5
2422-0003	20"x20"	Square	Lift-Out	S-K	20.3x20.3	517x517	22.8x22.8	579x579			2.5	0.31	0.9	ALUM	0.2	ALUM ALLOY	4	74	33.6
2462-0002	20"x20"	Square	Hinged	A-K	20.3x20.3	517x517	22.8x22.8	579x579	26.8x26.8	681x681	1.6	0.38	0.7	ALUM	0.2	ALUM ALLOY	4	45	20.4
2462-0003	20"x20"	Square	Hinged	S-K	20.3x20.3	517x517	22.8x22.8	579x579			2.5	0.31	0.9	ALUM	0.2	ALUM ALLOY	4	76	34.5
2423-0002	22"x22"	Square	Lift-Out	A-K	22.0x22.0	559x559	24.5x24.5	622x622	28.5x28.5	724x724	1.6	0.38	0.7	ALUM	0.2	ALUM ALLOY	4	45	20.4
2423-0003	22"x22"	Square	Lift-Out	S-K	22.0x22.0	559x559	24.5x24.5	622x622			2.5	0.31	0.9	ALUM	0.2	ALUM ALLOY	4	92	41.7
2463-0002	22"x22"	Square	Hinged	A-K	22.0x22.0	559x559	24.5x24.5	622x622	28.5x28.5	724x724	1.6	0.38	0.7	ALUM	0.2	ALUM ALLOY	4	46	20.9
2463-0003	22"x22"	Square	Hinged	S-K	22.0x22.0	559x559	24.5x24.5	622x622			2.5	0.31	0.9	ALUM	0.2	ALUM ALLOY	4	92	41.7
2423-0002	22"x22"	Square	Lift-Out	A-K	22.0x22.0	559x559	24.5x24.5	622x622	28.5x28.5	724x724	1.6	0.38	0.7	ALUM	0.2	ALUM ALLOY	4	45	20.4
2423-0003	22"x22"	Square	Lift-Out	S-K	22.0x22.0	559x559	24.5x24.5	622x622			2.5	0.31	0.9	ALUM	0.2	ALUM ALLOY	4	92	41.7
2424-0002	24"x24"	Square	Lift-Out	A-K	24.5x24.5	622x622	27.0x27.0	686x686	31.0x31.0	787x787	1.6	0.38	0.7	ALUM	0.28	ALUM ALLOY	4	57	25.9
2424-0003	24"x24"	Square	Lift-Out	S-K	24.5x24.5	622x622	27.0x27.0	686x686			2.5	0.31	0.9	ALUM	0.28	ALUM ALLOY	4	96	43.5

*DOES NOT INCLUDE HINGE POCKETS

**REQUIRES ESCAPE HANDLE AS STANDARD

Continued on next page



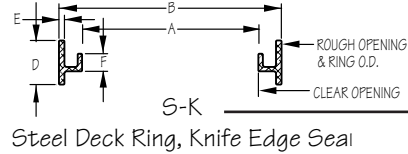
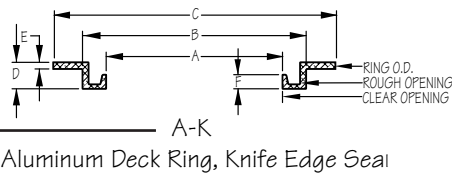

PART NO	SIZE	SHAPE	STYLE	RING	DIMENSIONS										MECHANISM		ASSEMBLY WEIGHT		
					CLEAR OPENING		ROUGH OPENING*		OVERALL					COVER		STD MATERIAL	DOG QTY		
					A (in)	A (mm)	B (in)	B (mm)	C (in)	C (mm)	D	E	F	MTRL	THKNESS		LBS	KGS	
2480-0106	24"x24"	Square	Hinged	A-K	24.8x24.8	630x630	27.3x29.2	693x742	31.2x35.2	793x894	1.6	0.38	0.7	D I	0.28	DUCT IRON	4	133	60.3
2480-0107	24"x24"	Square	Hinged	S-K	24.7x24.7	629x629	27.4x29.5	695x748			2.5	0.31	0.9	D I	0.28	DUCT IRON	4	155	70.3
2464-0002	24"x24"	Square	Hinged	A-K	24.5x24.5	622x622	27.0x27.0	686x686	31.0x31.0	787x787	1.6	0.38	0.7	ALUM	0.28	ALUM ALLOY	4	58	26.3
2464-0003	24"x24"	Square	Hinged	S-K	24.5x24.5	622x622	27.0x27.0	686x686			2.5	0.31	0.9	ALUM	0.28	ALUM ALLOY	4	97	44
2427-0002	27"x27"	Square	Lift-Out	A-K	27.2x27.2	690x690	29.6x29.6	752x752	33.6x33.6	854x854	1.6	0.32	0.8	ALUM	0.35	ALUM ALLOY	4	63	28.6
2427-0003	27"x27"	Square	Lift-Out	S-K	27.2x27.2	690x690	29.6x29.6	750x750			2.5	0.31	1.9	ALUM	0.35	ALUM ALLOY	4	85	38.6
2426-0006	30"x30"	Square	Lift-Out	A-K	30.0x30.0	762x762	32.5x32.5	826x826	36.5x36.5	927x927	1.6	0.25	0.7	ALUM	0.25	ALUM ALLOY	4	75	31
2426-0007	30"x30"	Square	Lift-Out	S-K	30.0x30.0	762x762	32.5x32.5	826x826			2.5	0.31	0.9	ALUM	0.25	ALUM ALLOY	4	113	51.3
2466-0006	30"x30"	Square	Hinged	A-K	30.0x30.0	762x762	32.5x32.5	826x826	36.5x36.5	927x927	1.6	0.25	0.7	ALUM	0.25	ALUM ALLOY	4	78	35.4
2466-0007	30"x30"	Square	Hinged	S-K	30.0x30.0	762x762	32.5x32.5	826x826			2.5	0.31	0.9	ALUM	0.25	ALUM ALLOY	4	114	51.7
2428-0002 0001**	36"x36"	Square	Lift-Out	A-K	36.0x36.0	914x914	39.3x39.3	998x998	42.0x42.0	1067x1067	2.5	0.31	0.9	ALUM	0.38	ALUM ALLOY	8	104	48
2428-0003 0001**	36"x36"	Square	Lift-Out	S-K	36.0x36.0	914x914	39.3x39.3	998x998			2.5	0.31	0.9	ALUM	0.38	ALUM ALLOY	8	134	60.8
2468-0002 0001**	36"x36"	Square	Hinged	A-K	36.0x36.0	914x914	39.3x39.3	998x998	42.0x42.0	1067x1067	2.5	0.31	0.9	ALUM	0.38	ALUM ALLOY	8	119	54
2468-0003 0001**	36"x36"	Square	Hinged	S-K	36.0x36.0	914x914	39.3x39.3	998x998			2.5	0.31	0.9	ALUM	0.38	ALUM ALLOY	8	149	67.6

*DOES NOT INCLUDE HINGE POCKETS **REQUIRES ESCAPE HANDLE AS STANDARD

Advantec Marine
WE HAVE YOU COVERED.

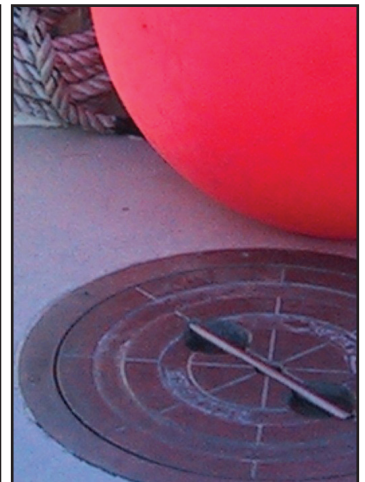
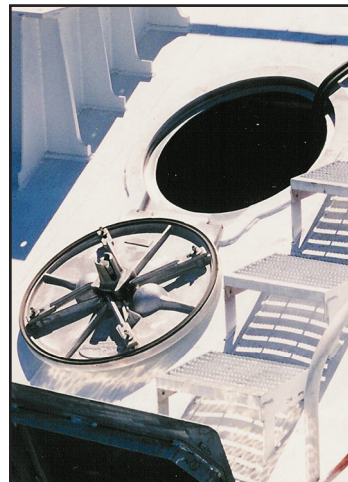

ISO 9001:2015

QUICK SHIP = QUICK AVAILABILITY AND GUARANTEED QUALITY

These items are in stock or ready to ship within 3 weeks or less, guaranteed. If not, AdvanTec Marine will pay for ground shipping within the Continental North America*. *Excluding Alaska & Hawaii.

250 SERIES WEATHERTIGHT DOORS

250 HINGED DOOR & 250 DUTCH DOOR

- Marine Grade .090" Aluminum Captured Panel Skins Mill Finish
- Welded 6063 Flanged Aluminum Frame
- 4" Radius Corners
- Gasket on Frame
- Insulation Korolite Rigid Foam Core
- Bolt-in or Weld-in Frames
- (2) Individual Nylon Dogs
- Stainless Steel Hinges and Fasteners
- Trioving Lockset with 3 keys

Check our website for available sizes - advantecglobal.com/stockdoors/

1212 SERIES WATERTIGHT DOORS

HINGED WATERTIGHT DOOR

- Marine Grade Interprime 198 Red Oxide Primer Finish
- Welded Mild Steel, Radius Formed Corners
- Gasket on Door Panel for Long Life and Positive Sealing
- .250" Thick, Outside Mild Steel Panel
- (4) Individual Dogs
- (3) Welded Steel Panel Hinges
- Inside and Outside Round-bar Steel Handles

Check our website for available sizes - advantecglobal.com/stockdoors/

300X SERIES SLIDING DOORS

SINGLE PANEL SLIDING DOOR

- Commercial Duty Closure Designed for Offshore Use
- Marine Grade 6063 Aluminum
- Mill Finish
- Insulation Korolite Rigid Foam Core
- Tempered Window
- Trioving Lockset with 3 keys

Check our website for available sizes - advantecglobal.com/stockdoors/



250 Hinged



250 Dutch



1212 Watertight

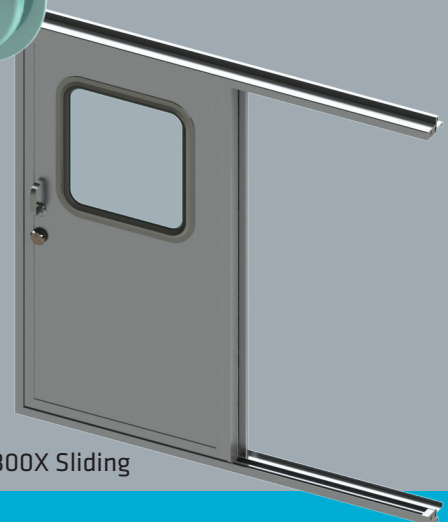

300X Sliding

AdvanTec Marine

QUICK SHIP. READY TO ORDER.

AdvanTec Marine Supplies:

• **MARINE** • **RAIL** • **CIVIL** • **INDUSTRIAL**

**ADVANTEC MARINE IS CONSTANTLY DEVELOPING
NEW COMPONENTS AND SPECIALTY SOLUTIONS**



Diamond
Sea Glaze



FREEMAN
MARINE EQUIPMENT



PACIFIC COAST
MARINE



STEELHEAD
MARINE

DESIGN: SolidWorks, AutoCAD, 3-D Modeling, FEA.

FABRICATION: Frame and panel makers, specialty shape bending (automated extrusion benders, CNC press brake forming, plate rolls), aluminum/steel/stainless steel welding (MIG/TIG), MIL-W-248C welding process.

MACHINE SHOP: Milling, spline cutting, grinding, drilling, turning, sawing, broaching, plasma cutting, CNC equipment.

FOUNDRY: Aluminum green sand castings, small to medium runs, mold size from ounces to 200+ pounds, large flat and thin parts, specialty, 356 and 535 alloys, 10,000 sq. ft. foundry space with full travel overhead bridge crane.

ASSEMBLY: Bolt, rivet, weld, bond, press, clamp, advanced adhesive and insulation techniques as well as specialized assembly methods.

FINISHING: Vibratory surface conditioning, shot and sand blasting, sanding, polishing, painting— cross flow and down draft booths (up to 18' assemblies in one piece)— prep/primer/topcoat, powder coating, passivation, electro polish, heat treating, heat/environment controlled applications.

QUALITY CONTROL: ISO 9001:2015 registered, dimensional inspection, MIL-I-45208A approved systems, calibrated test devices, material control, nondestructive testing – weld testing (penetrant, radiographic), leak testing (ultrasonic, hydrostatic, air jet, pneumatic, chalk), chemical and physical analysis, salt spray corrosion testing, sand laboratory for casting process control.

PATTERN MAKING: Wood, metal, plastic and master pattern production for sand castings, aluminum match plate construction, gating and riser development and pattern repair. **TOOL & DIE MAKING:** Precision prototype and production tool and die design, development and fabrication.

• HATCHES

AdvanTec offers a wide range of watertight custom fabricated panel and lens-type hatches as well as the world's most extensive line of standard-sized, patented-design, quick-acting cast aluminum flush deck hatches. Whatever your requirements, AdvanTec MARINE can produce the special shapes, cambers, lensing, teak overlay prep, hinge options and finishes needed for your project. Commercial style hatches available.

• DOORS

Ruggedly built with precision working components of aluminum, steel, stainless steel, and other quality materials. A variety of single lever actuation for quick-acting mechanisms or individual dogging. Unique chain drive system accommodates complex shapes not possible with other dogging designs. Surface, concealed, yoke and pantograph hinge styles are available. Knife-edge or compression sealing systems. Weathertight or watertight designs for specific applications anywhere, to match the sealing requirement. Many panel styles available including single, French, Dutch, gull wing, and sliding. Double skin insulated panels or single skin bulkhead doors. Commercial style bulkhead doors a specialty.

• PORTLIGHTS

Premium Portlights are precision machined from Almag 35 castings and finished to the highest standards. Modular concepts allow easy accessory upgrade and interchangeability. Available custom painted in linear polyurethane, powder coated, anodized finishes. Commercial style portlights available.

• WINDOWS

All vessels require different degrees of protection from the elements. AdvanTec MARINE offers a comprehensive range of windows from Standard Duty (clamp- grip) up through Heavy-Duty (bolt-in, weld-in) styles.

AdvanTec Marine

HATCHES. DOORS. PORTLIGHTS. WINDOWS.

AdvanTec Marine is a member of the Advantec Global Group.
For more information go to: www.advantecglobal.com

ISO 9001:2015



1. Chilliwack, BC, Canada, Head Office



Capabilities:
bending extrusion for windows & hatches custom glass (glass cutting, glass tempering, ceramic printing on glass) custom fabrication, wet paint & powder coating, hydraulics full machine shop custom doors and closures, aluminum foundry (cast hatches, cast aluminum marine equipment).

5,436 Acre Lot, 81,926 sq. ft. Manufacturing Space
43676 Progress Way
Chilliwack, BC, V2R 0C3



1. CHILLIWACK, BC

4. CALGARY, AB

2. MAPLE RIDGE, BC

5. LANGLEY, BC

3. GOLD BEACH, OR

6. LYNNWOOD, WA

7. ROBERTSDALE, AL



AdvanTec Marine



Diamond Sea Glaze



FREEMAN MARINE EQUIPMENT



PACIFIC COAST MARINE



STEELHEAD MARINE

AdvanTec Marine

7 Locations. To Better Serve You.

2. Maple Ridge, BC, Canada



Capabilities:
pressure pipe and fittings, pressure vessels, helical coils), heater & boiler pipe coiling, engineering & integration pressure pipe welding, large diameter piping & penstock painting.

27222 Lougheed Hwy
Maple Ridge, BC, V2W 0C9

3. Gold Beach, OR, USA



Capabilities:
design, fabrication, machine shop, foundry, assembly, finishing, quality control, pattern making, tool and die making, material handling, packaging, part sales.

28336 Hunter Creek Rd.
Gold Beach, OR 97444

4. Calgary, AB, Canada



Capabilities:
pressure pipe and fittings, pressure vessels, helical coils), heater & boiler pipe coiling, engineering & integration pressure pipe welding, large diameter piping & penstock painting.

5250 94 Ave SE
Calgary, AB, T2C 4E5

5. Langley, BC, Canada



Capabilities:
structural bending, tube bending, specialty bending, architectural bending, aess, steel bridges, tunnel arches, pipe bending

27372 Gloucester Way
Langley, BC, V4W 4A1

6. Lynnwood, WA, USA



Sales Office and Service & Warranty Office

Suite A-106, 16531 13th Ave.
West Lynnwood, WA 98037

7. Robertsdale, AL, USA



Capabilities:
bending extrusion for windows & hatches, custom glass (glass cutting, glass tempering, ceramic printing on glass), custom fabrication, wet paint & powder coating.

22955 MacAuliffe Drive,
Robertsdale, AL, 36567

CONSULT

CREATE

DESIGN

MANUFACTURE

DELIVER

INNOVATION

ISO 9001:2015