



**HYDRO ARMOR**

# Cranes - assortment



600 kg  
5.00 m



800 kg  
5.45 m

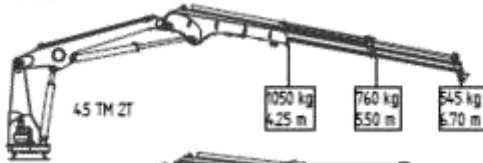

760 kg  
5.50 m

545 kg  
6.70 m

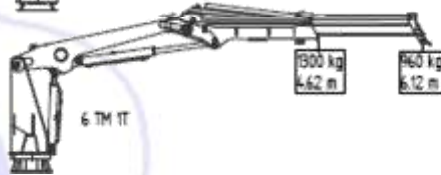

960 kg  
6.12 m

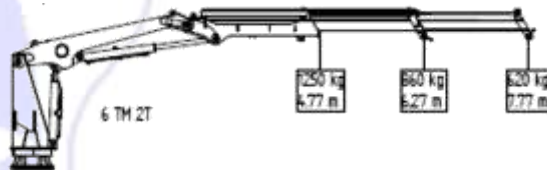

860 kg  
5.27 m

620 kg  
7.77 m

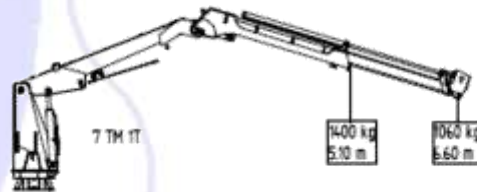

1060 kg  
6.60 m

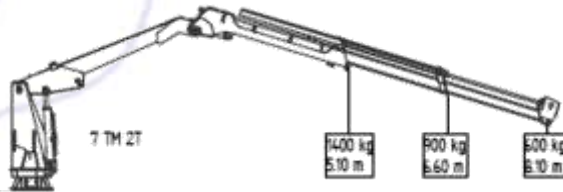

900 kg  
5.60 m

500 kg  
6.10 m

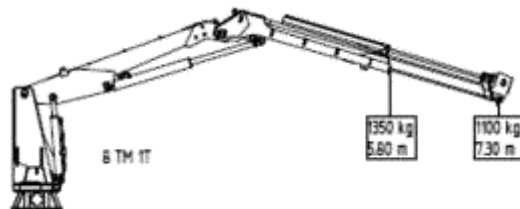

1100 kg  
7.30 m

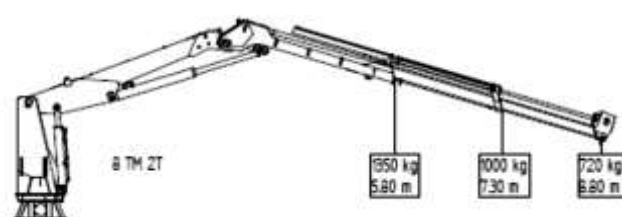

1000 kg  
7.30 m

720 kg  
6.80 m

# Cranes - assortment

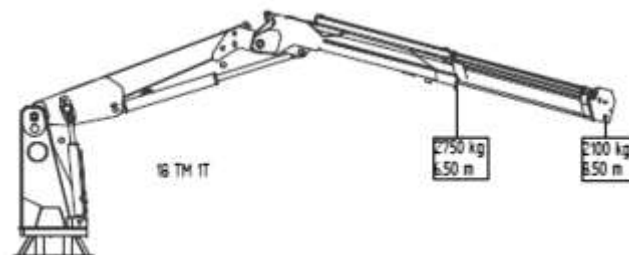
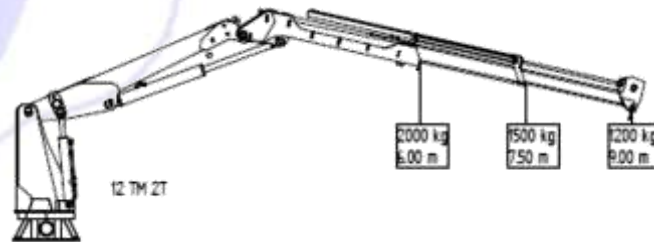
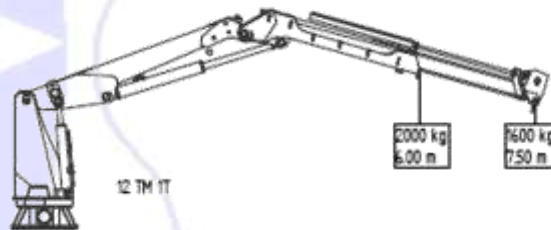
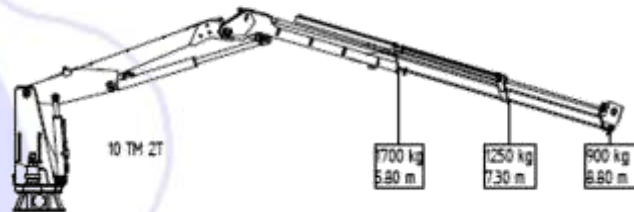
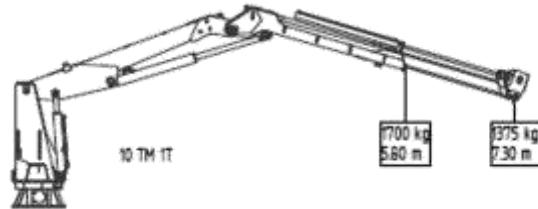

# Cranes - assortment

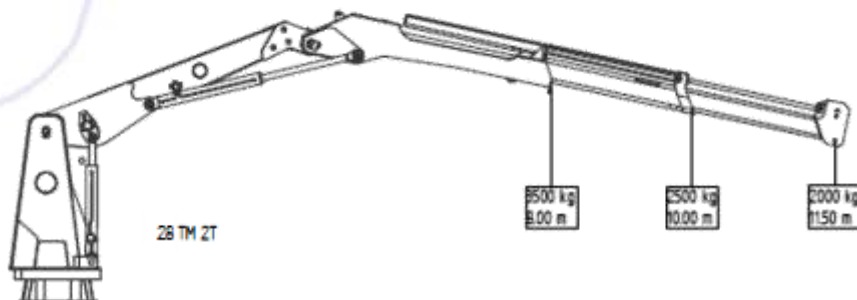
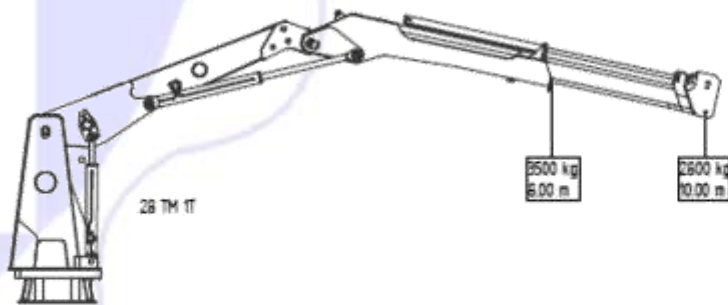
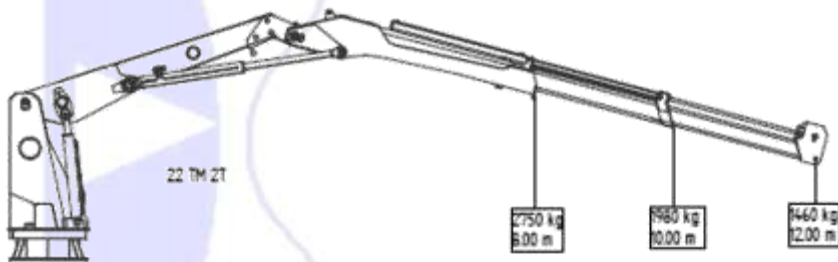
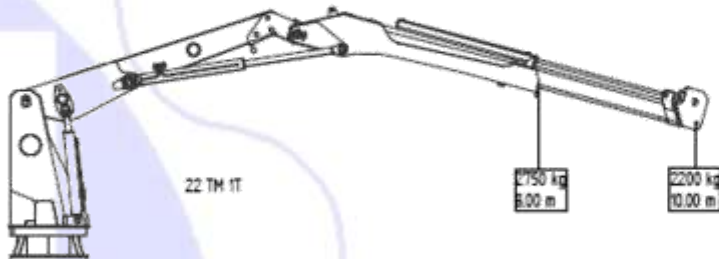
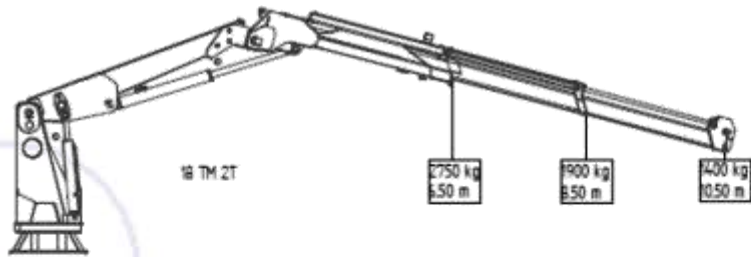

# Cranes - assortment

